

WP24-30

Constant Voltage LED Driver



Description

30W 24V DC Weatherproof Constant Voltage LED Driver for use on LED strip lighting, garden lights, inground uplighters and much more. Complete with flex and plug. Backed by a 3 Year replacement Warranty.

Specification Features

Input Voltage (AC):	200-260V 50/60Hz
Output Voltage (DC):	24V DC
Output Wattage (W):	3 - 30W
Flex and Plug:	Yes
IP Rating (IP):	67
Dimensions:	(L) 120mm x (W) 44mm x (H) 32mm
Warranty:	3 Year Replacement
Wiring:	Wire in Parallel
Protection:	Short Circuit, Over Voltage, Over Temperature & Overload



Diagrams / Additional

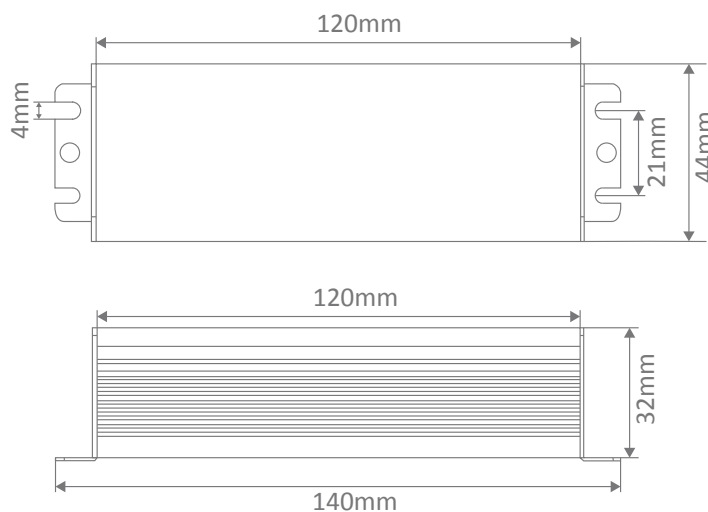

Item No.	Variant
DRIVER-WP24V	20251