

Last modification

2023-12-10

MONTEAL PE1-AGBK 9329501065341



Elevate your home with the Montreal Pendant Family, radiating a contemporary charm through its open lantern design. The black iron frame exudes modern elegance, complemented by a striking gold satin crown. With a tapering silhouette and timeless appeal, this pendant light is available in three sizes, offering versatile options to illuminate your space with style and sophistication.

Overview

Family name	Monteal
Categories	Pendants
Mounting	Surface
This item includes	Suspension
Shade Shape	Drum Tapered
Suspension Type	Chain
Usage	Indoor Lighting

Color / Material

Fixture Color	Black, Antique Gold
Fixture Material	Iron
Base Material	Iron

Size

Fixture Width (cm)	25.0
Fixture Height (cm)	45.0
Canopy Length (cm)	12.0
Canopy Projection (cm)	2.5
Canopy Width (cm)	12.0
Suspension Length (cm)	200.0
Height Adjustable?	Yes

Specification

Voltage Input	240V
Total Wattage (max)	25
Globe Type	E27
Globe / Light Source qty	1

All representations within this document are subject to copyright. ELECTRICAL INSTALLATIONS MUST BE PERFORMED BY A QUALIFIED ELECTRICAL CONTRACTOR AND INSTALLED IN ACCORDANCE WITH AS/NZS 3000.
NOTE : All images , descriptions and dimensions are indicative. Please check latest version of item detail on Telbix website prior to ordering or installation.

Globe / Light Source included	No
Dimmable	Globe Dependant
Electrical Protection	CLASS I - HIGH VOLTAGE, EARTH REQUIRED
IP rating	IP20
Lead and Plug	No
Approvals	RCM
Installation Required	Yes (by Licensed Electrician only)
Care Instructions	Wipe clean with a dry cloth, Do not use strong liquid cleaners
Replacement Warranty	*3 Years

Barcode

GTIN 9329501065341

Image -dimensions

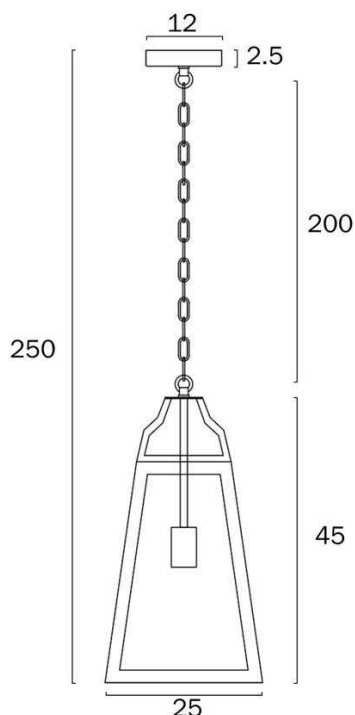

Note: Dimensions are only a guide and may vary due to manufacturing variations.

Globe Type Recommended

Label	Color Temperature	Thumbnail	GTIN
GL F.PILT.4-AM83	Warm White		9329501042694
GL F.PILT.8-CL83	Warm White		9329501052181
GL F.PILT.8-CL85	Cool White		9329501056097