

ITEM NO.:GILSON WB60

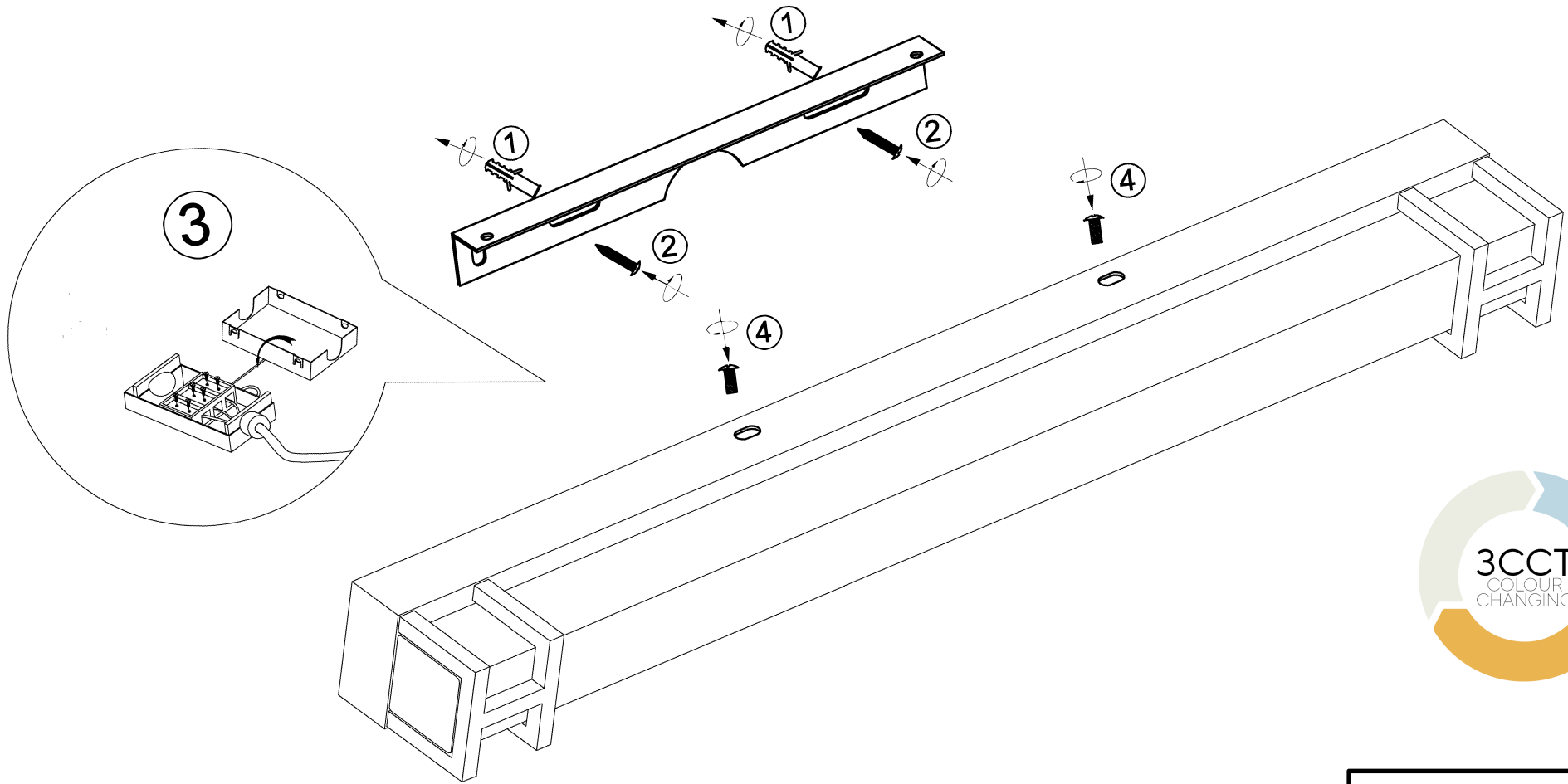

240V ~ 50Hz LED 12W 3000K-4000K-5000K

IMPORTANT
Must be installed by
a qualified electrical
contractor.
Install in accordance
with AS/NSZ3000



Telbix.