

Last modification

2022-08-12

## EAMON PE8-BKOM

9329501060759



The EAMON lighting family is round and radiant and will give any room an upscale update. The hand crafted circular frame host the mouth blown opal matt cylindrical shades that will provide perfect lighting for dining and living areas. Available as a 2 light wall lamp and a 6 or 8 light pendant, and finished in Black or Brass matt.

### Overview

<b>Family name</b>	Eamon
<b>Categories</b>	Pendants
<b>Mounting</b>	Surface
<b>This item includes</b>	Glass,Suspension
<b>Suspension Type</b>	Rod (1x300)+(2x600)
<b>Usage</b>	Indoor Lighting

### Color / Material

<b>Fixture Color</b>	Black,Opal Matt
<b>Fixture Material</b>	Iron,Glass
<b>Canopy Color</b>	Black
<b>Shade Material</b>	Glass
<b>Glass Color</b>	Opal Matt

### Size

<b>Fixture Diameter (cm)</b>	85.0
<b>Fixture Height (cm)</b>	22.0
<b>Shade Diameter (cm)</b>	8.0
<b>Suspension Length (cm)</b>	150.0

### Specification

<b>Voltage Input</b>	240V
<b>Wattage (max)</b>	200
<b>Wattage</b>	25
<b>Globe Type</b>	E14
<b>Globe / Light Source qty</b>	8
<b>Globe / Light Source included</b>	No

All representations within this document are subject to copyright.ELECTRICAL INSTALLATIONS MUST BE PERFORMED BY A QUALIFIED ELECTRICAL CONTRACTOR AND INSTALLED IN ACCORDANCE WITH AS/NZS 3000.  
NOTE : All images , descriptions and dimensions are indicative. Please check latest version of item detail on Telbix website prior to ordering or installation.

<b>Electrical Protection</b>	CLASS I - HIGH VOLTAGE, EARTH REQUIRED
<b>IP rating</b>	IP20
<b>Approvals</b>	RCM
<b>Assembly Required</b>	Yes
<b>Box Contents</b>	Basic mounting screws, Instruction
<b>Installation Required</b>	Yes (by Licensed Electrician only)
<b>Care Instructions</b>	Do not use strong liquid cleaners, Wipe clean with a dry cloth
<b>Warranty</b>	3 Years

Barcode

**GTIN** 9329501060759

Image -dimensions

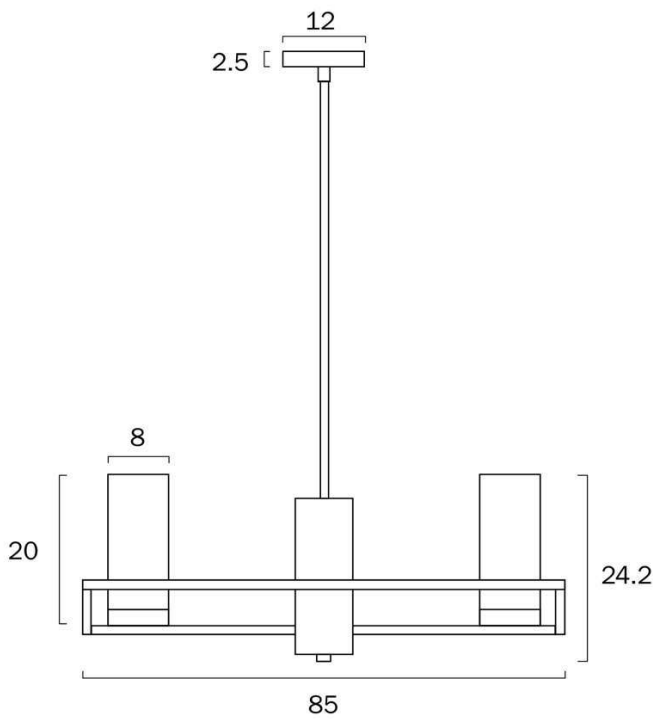

Note: Dimensions are only a guide and may vary due to manufacturing variations.





Last modification 2022-08-12

## EAMON PE8-BRSOM 9329501060551



The EAMON lighting family is round and radiant and will give any room an upscale update. The hand crafted circular frame host the mouth blown opal matt cylindrical shades that will provide perfect lighting for dining and living areas. Available as a 2 light wall lamp and a 6 or 8 light pendant, and finished in Black or Brass matt.

### Overview

<b>Family name</b>	Eamon
<b>Categories</b>	Pendants
<b>Mounting</b>	Surface
<b>This item includes</b>	Glass,Suspension
<b>Suspension Type</b>	Rod (1x300)+(2x600)
<b>Usage</b>	Indoor Lighting

### Color / Material

<b>Fixture Color</b>	Brass,Opal Matt
<b>Fixture Material</b>	Iron,Glass
<b>Canopy Color</b>	Brass
<b>Shade Material</b>	Glass
<b>Glass Color</b>	Opal Matt

### Size

<b>Fixture Diameter (cm)</b>	85.0
<b>Fixture Height (cm)</b>	22.0
<b>Shade Diameter (cm)</b>	8.0
<b>Suspension Length (cm)</b>	150.0

### Specification

<b>Voltage Input</b>	240V
<b>Wattage (max)</b>	200
<b>Wattage</b>	25
<b>Globe Type</b>	E14
<b>Globe / Light Source qty</b>	8
<b>Globe / Light Source included</b>	No

All representations within this document are subject to copyright.ELECTRICAL INSTALLATIONS MUST BE PERFORMED BY A QUALIFIED ELECTRICAL CONTRACTOR AND INSTALLED IN ACCORDANCE WITH AS/NZS 3000.  
NOTE : All images , descriptions and dimensions are indicative. Please check latest version of item detail on Telbix website prior to ordering or installation.

<b>Electrical Protection</b>	CLASS I - HIGH VOLTAGE, EARTH REQUIRED
<b>IP rating</b>	IP20
<b>Approvals</b>	RCM
<b>Assembly Required</b>	Yes
<b>Box Contents</b>	Basic mounting screws, Instruction
<b>Installation Required</b>	Yes (by Licensed Electrician only)
<b>Care Instructions</b>	Do not use strong liquid cleaners, Wipe clean with a dry cloth
<b>Warranty</b>	3 Years

## Barcode

**GTIN** 9329501060551

## Image -dimensions

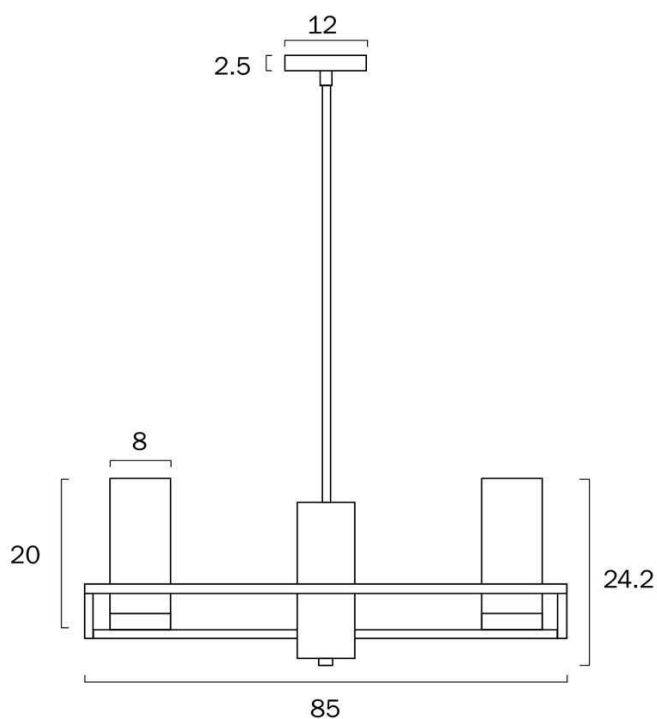

Note: Dimensions are only a guide and may vary due to manufacturing variations.



