

# ITEM NO.: EAMON PE8

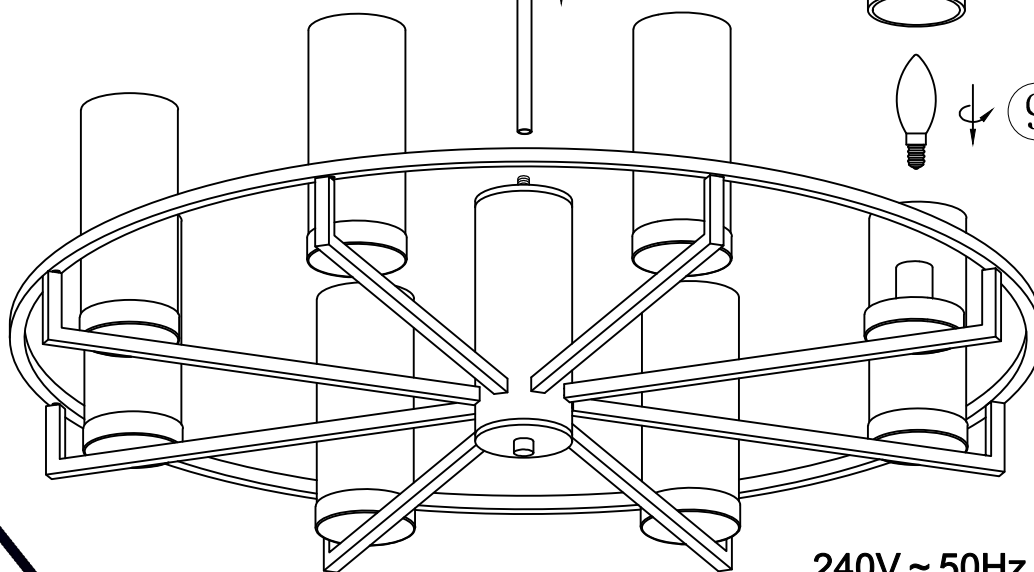

**IMPORTANT**  
Must be installed by  
a qualified electrical  
contractor.  
Install in accordance  
with AS/NZ3000

- Disclaimer:  
/ Tools not included  
Shade ring attached on lamp holder  
Globe(s) not included

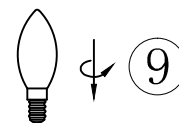
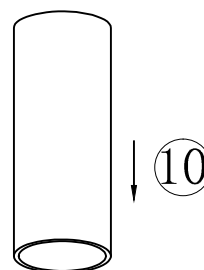
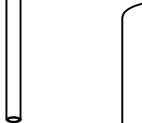
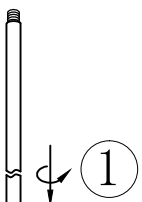
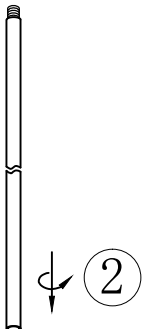
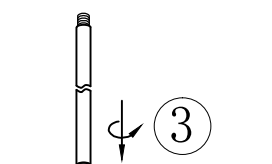
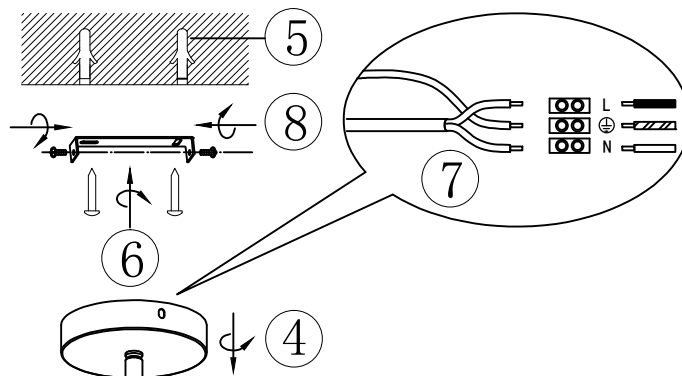

**Telbix.**

240V ~ 50Hz E14Max.25Wx8

NOTE:GLOBE NOT INCLUDED