

ITEMNO.:TARSON PE1T

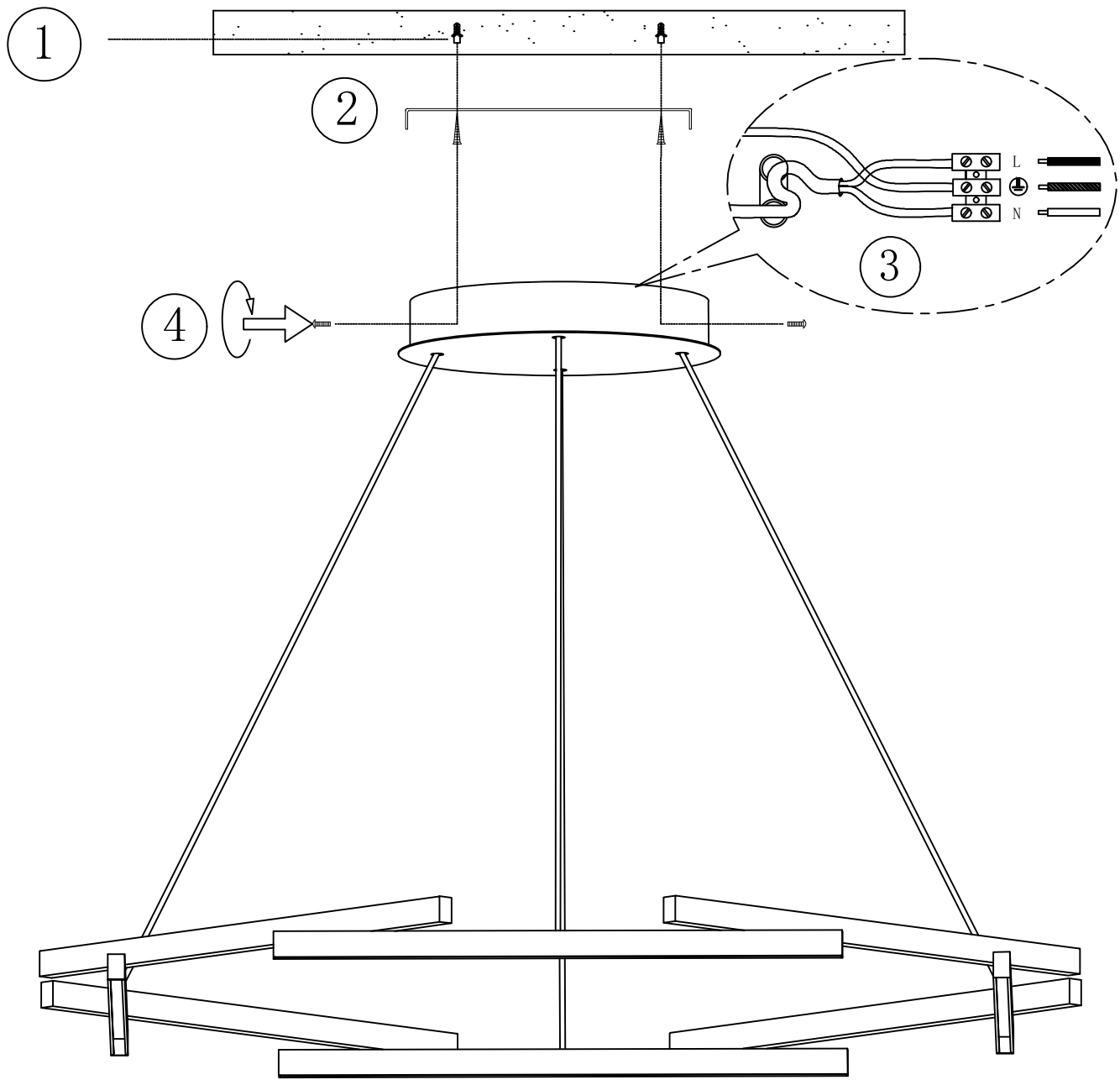

240V ~ 50Hz LED 40W
3000K NO-DIM

IMPORTANT
Must be installed by a qualified electrical contractor.
Install in accordance with AS/NZS3000