

STAR-PD-300

Date: 05/2018

Variant	Item No.	Description
21051	STAR-PD-5W-300-BLK	5W LED Pendant Light, 3000K Warm White. Black Finish
21052		5W LED Pendant Light, 4000K Neutral White. Black Finish
21053		5W LED Pendant Light, 5000K White. Black Finish
21054	STAR-PD-5W-300-WHT	5W LED Pendant Light, 3000K Warm White. Satin White Finish
21055		5W LED Pendant Light, 4000K Neutral White. Satin White Finish
21056		5W LED Pendant Light, 5000K White. Satin White Finish

Thank you for purchasing your new LED STAR-PD-300, Please take the time to read and understand the instruction sheet below. Failure to do so may void warranty.

Specifications

Voltage:	240V	Lumen (±5%):	Warm White 3000K - 500lm Neutral White 4000K - 530lm White 5000K - 550lm	Dimmable:	NO
Power:	5W	Beam Angle:	60°	Operating Temp:	-20°C~45°C
IP Rating:	IP20	CCT:	3000K - 4000K - 5000K	Power Factor:	0.8
CRI:	≥80	Lifespan:	50,000hrs		

1. Take out the accessories from the accessory box

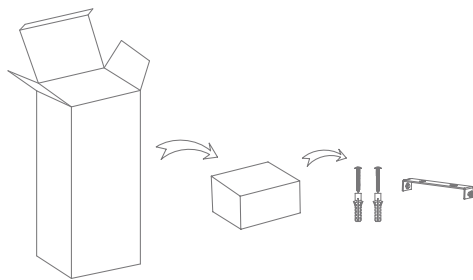

2. Determine mounting location and knock the plastic anchor into ceiling, fix the bracket and screw into ceiling.

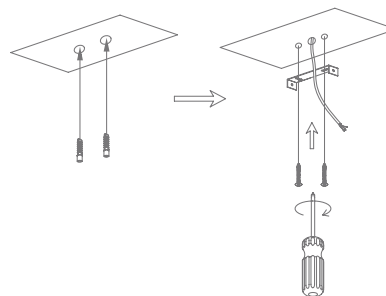

3. Take lamp out of the box, connect the corresponding polarities between the wires on the ceiling and terminal by screwdriver.

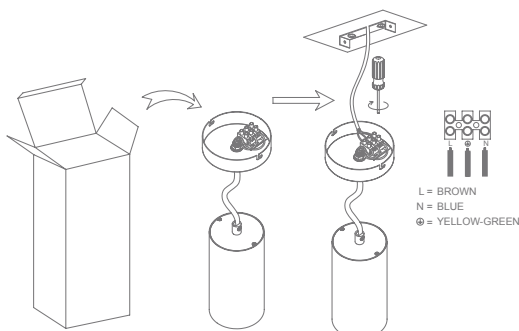

4. Properly align the mounting holes between back plate and mounting bracket, then lock them together with screw,

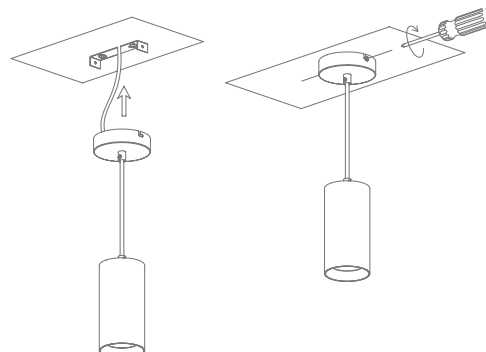

Note: -The lamp must be installed by professional electrician
-Ensure the power supply is switched off before fitting this product

-Do not touch the lamp when in use
-Keep away from hot steam and corrosive gas