

ITEM NO.: PINTA PE08

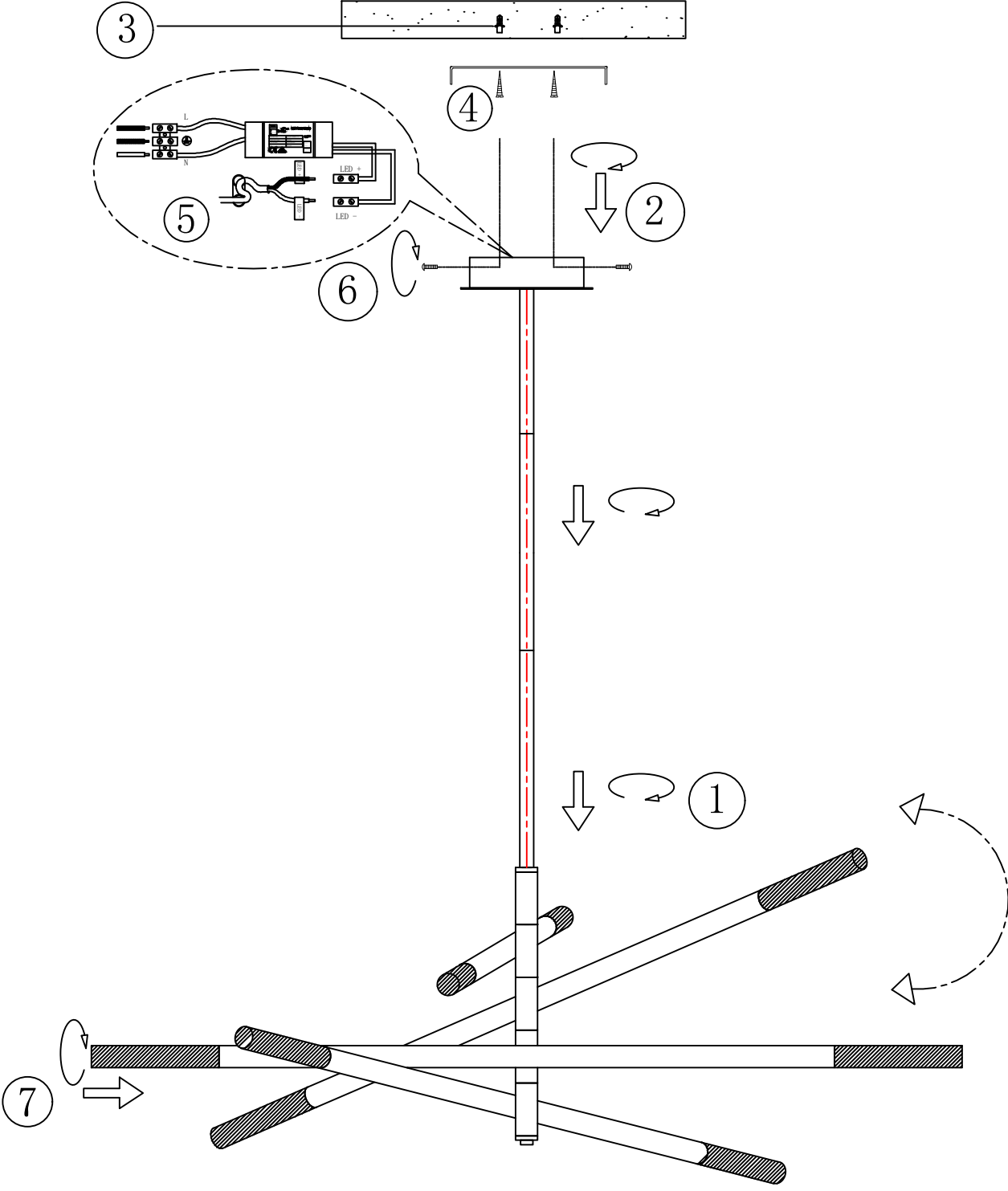

IMPORTANT
Must be installed by
a qualified electrical
contractor.
Install in accordance
with AS/NZS3000



Telbix.

240V ~ 50Hz LED 3Wx8
3000K NO-DIM