

# Profile Plus **LED**

**MARTEC**<sup>®</sup>

## Profile Plus 2



### FEATURES

- /// 2 year In Home warranty
- /// Excellent airflow 460m<sup>3</sup> / h
- /// Long life ball bearing motor
- /// Quiet operation
- /// Turbo fan blade
- /// Duct outlet (120mm diameter)
- /// Removable grill 2x 275W heat lamps included
- /// 3x 6w 3000K GU10 (MBGU306) LED lamps included
- /// 1x 3-Gang switch included
- /// Draft stopper, side ducting, and grill included
- /// Remote control adaptable (MBHREM)



**MBHP2LW**

### DIAGRAM

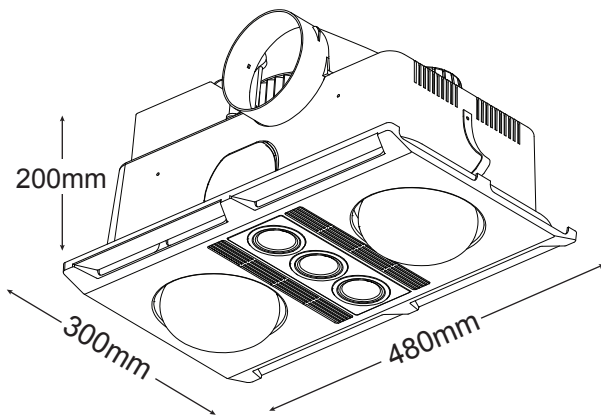

**MBHP2LS**

2 x 275W instant heat infrared heat lamps

3 x 6W GU10 LED Lamps

CUT OUT SIZE 435mm x 255mm

GRILL SIZE 480mm x 300mm

LUMEN 1080lm

Minimum ceiling depth of 210mm is required