

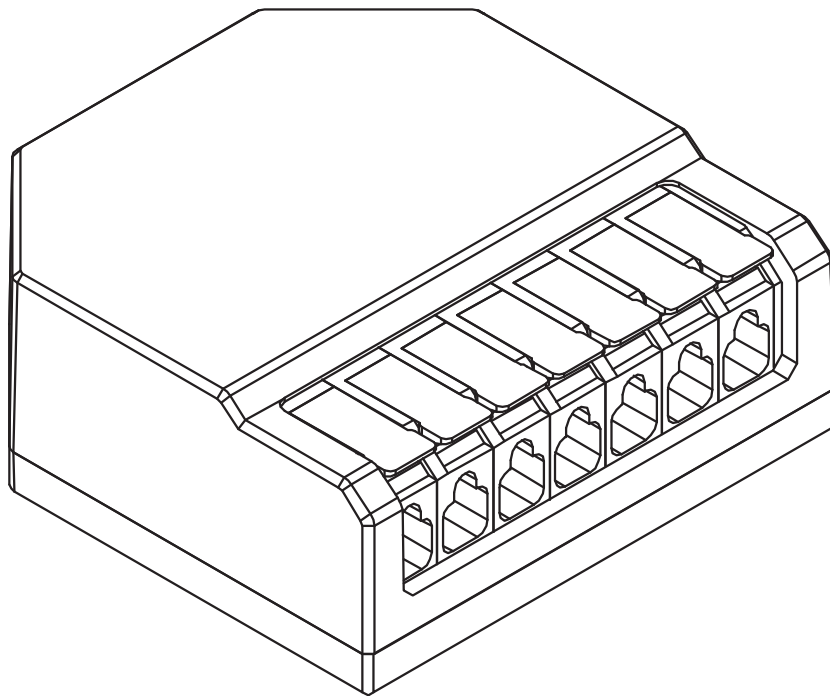

HV9271

Installation Instructions



1 CH Wireless DC Dimmer

A. PRODUCT SPECIFICATIONS

1CH

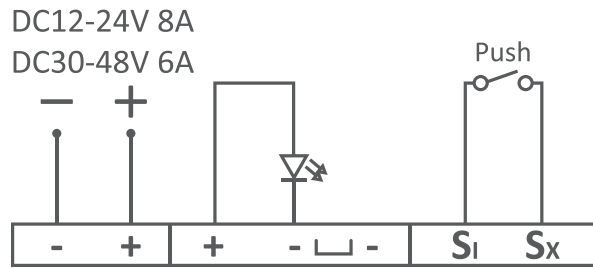
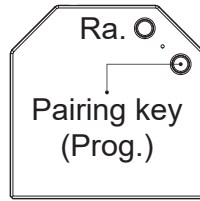
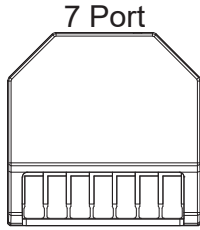

PRODUCT CODE	HV9271
LOAD	12-24 Vdc 8A Max 30-48 Vdc 6A Max
RADIO FREQUENCY	433Mhz
SMART PROTOCOL	\
WALL SWITCH COMPATIBLE	Yes
CHANNEL	1CH
IP RATING	IP20
TEMP. RANGE	-20 ~ 40°C
HOUSING TEMP.	Ta: 40°C Tc: 80°C
LIFETIME	50000 Hours

B. PRODUCT DIMENSIONS

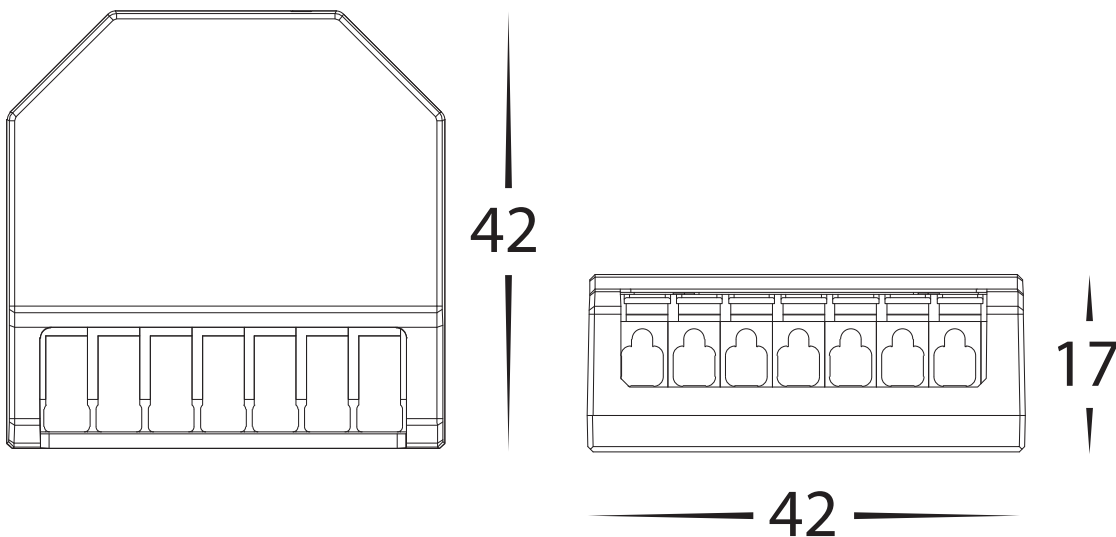

C. INSTALLATION

CAUTIONS:



Do not over-lift the lockup arms on the terminals.
Max opening angle is within 30° from the closed position.

Cable Size: 0.8-2.5mm²

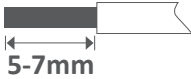

(a)

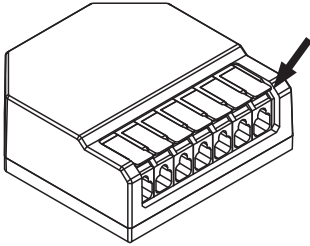

(b)

Lift up the lockup arms.

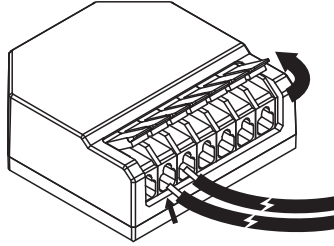

(c)

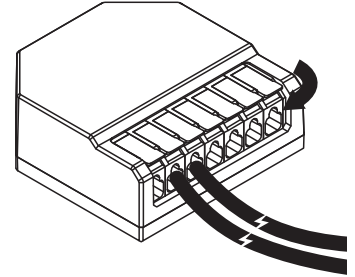

D. WIRING DIAGRAM

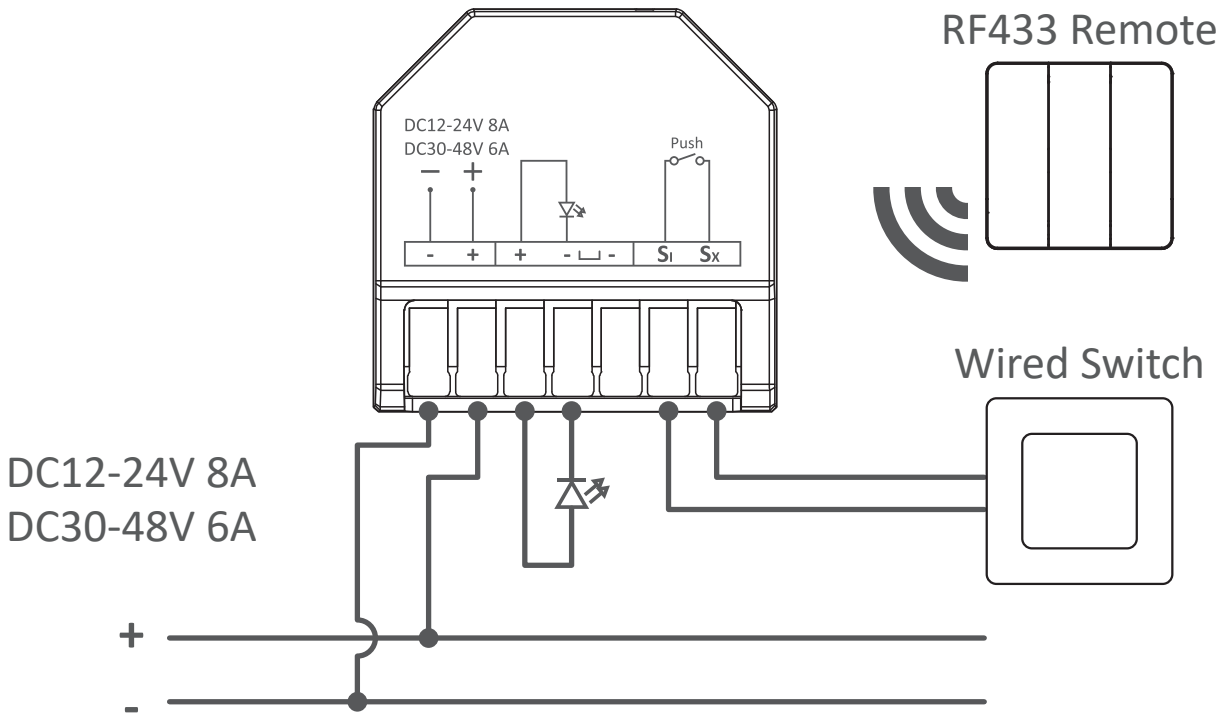

- a. Power must be turn off before installation.
- b. Installation must be carried out by professional electrician.

*Usage method of the Wired Switch

Push Switch			
On/Off	Short Press	Dimmer	Long Press

E. PAIRING PROCESS OVERVIEW

Short Press Prog. Key to:

- Turn On (Indicator: Steady Green Light)
- Turn Off (Indicator: Flashing Green Light)

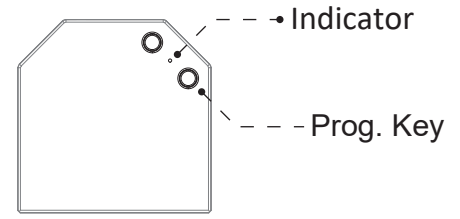

Long Press Prog. Key:

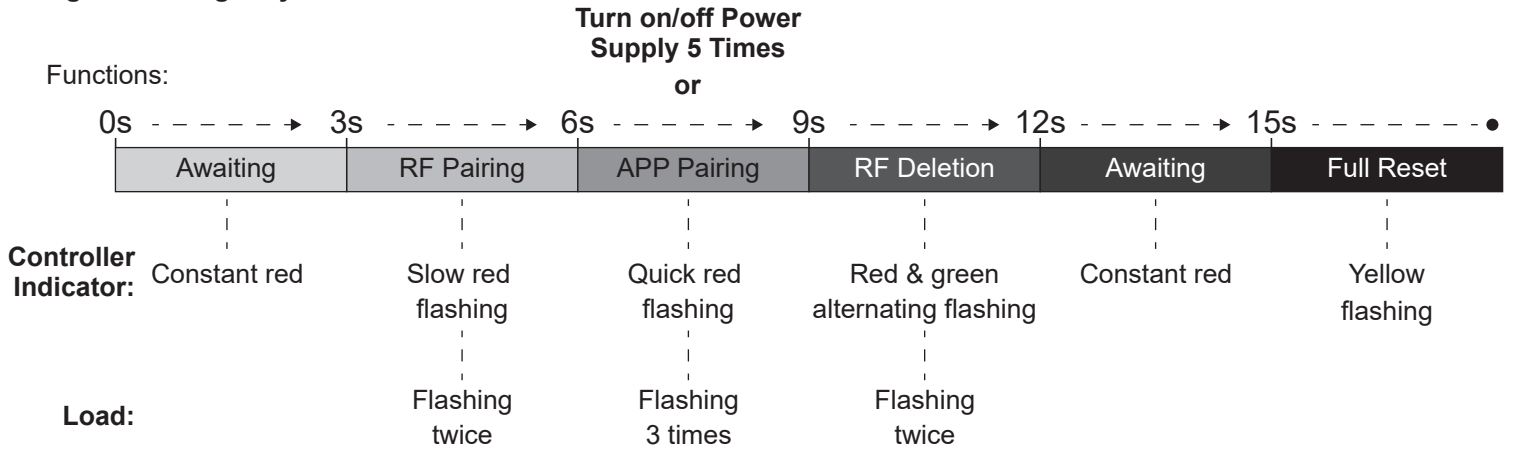

F. PAIRING WITH REMOTE

Option 1.

- Press and hold the Prog. Key for **3s** until the **RED** indicator flashes slowly, and release to enter RF pairing window (the light will flash **Twice** and stay on).
- While the RED indicator on the controller is flashing slowly, press the switch key or power key of remote **ONCE** to complete the pairing.

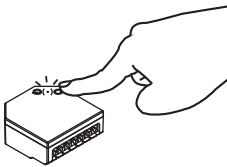

Hold on Prog. key over **3s**
Indicator: **RED** flashes **slowly**

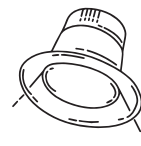

Light flash **Twice**
and stay on

*If there is no operation within 30 seconds, the LED will blink once and exit the key-pairing mode, entering the normal working mode.

Option 2. (Quick Pairing)

Within 4s after power is up, receiver would have a 4s pairing window. Press intended switch key 3 times within 1s to complete the pairing.

Option 3. (Use paired switch to pair new switch)

Use a paired switch to turn on the light first, and then quickly press the paired switch key 8 times in 3s, the light flashes twice, entering pairing mode (10s).

During the pairing mode, press the intended RF switch key or power key 3 times in 1s to complete the pairing.

*If there is no operation within 10 seconds, the LED will blink once and exit the key-pairing mode,

*COMPATIBLE DEVICES (ORDER SEPARATELY)

1. Self Powered Switches

*Please refer to the related RF remotes instruction manual on how to work.



HV9261



HV9262

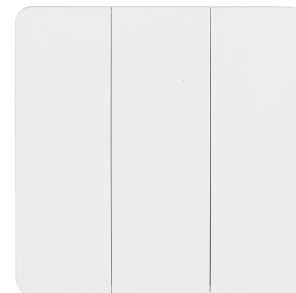

HV9263

H. UNPAIRING SWITCH AND REMOTE

Option 1: Press and hold the Prog. Key for **9s** until the indicator to **flash alternately between RED and GREEN** and release to enter RF remote removing window (the light would flash **twice** and stay on).

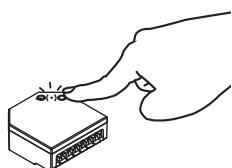

Hold on Prog. over **9s**
Indicator: **RED & GREEN**
alternating flashing

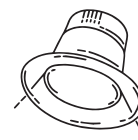

Light flash **Twice**
and stay on

Option 2: Press the pairing button on a paired RF remote **8 times within 3s**, the light flashes **twice**, entering pairing mode (**10s**). During this time, press the paired RF remote **5 times within 2s** to unpair.

*If there is no operation within 10 seconds, the LED will blink once and exit the key-pairing mode, entering the normal working mode.

I. FULL FACTORY RESET

Press and hold the Prog. Key for **15s** until the indicator flashes **YELLOW** to complete a full factory reset (the light would flash **5 times** and stay on).

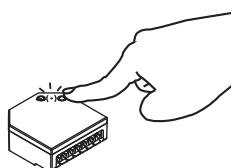

Hold on Prog. key over **15s**
Indicator: **YELLOW** flashing

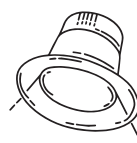

Light flash **5 times**
and stay on

*Note: this will clear all RF Remote and APP pairings on this controller!

J. MINIMUM BRIGHTNESS SETTING

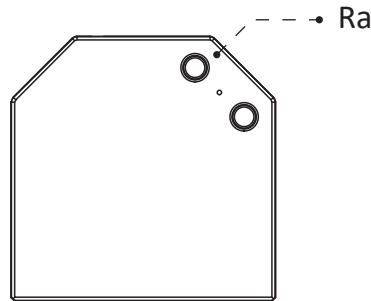

Ra key is used to set the minimum dimming level of the dimmer receiver to avoid flickers and light being completely turned off in use to improve the compatibility.

Once the minimum dimming level is set, the dimmer receiver would not dim below the set level.

How to use Ra Key:

You may choose the minimum dimming level at any time through press the Ra Key if required.

Single press the **Ra Key** to set the dimming level.

10 minimum dimming levels are provided on the dimmer receivers. Press the Ra Key once to increase 1 level, until to the 10th level and it will return back to 1st level and so on.

Set the minimum dimming level

Once you reached the minimum dimming level, leave the dimmer receiver as it. It shall automatically remembers the set level to operate, i.e. it will not dim the load or light below this level, even using App with a clear brightness percentage, the dimmer receiver would keep the set level as the lowest level to operate.

Contact Details:

143 Beauchamp Road
Matraville NSW 2036
Australia

Tel: 02 9381 8300
Fax: 02 9666 8881
Email: sales@havit.com.au
Web: www.havit.com.au

Warranty Terms & Conditions*



www.havit.com.au

