

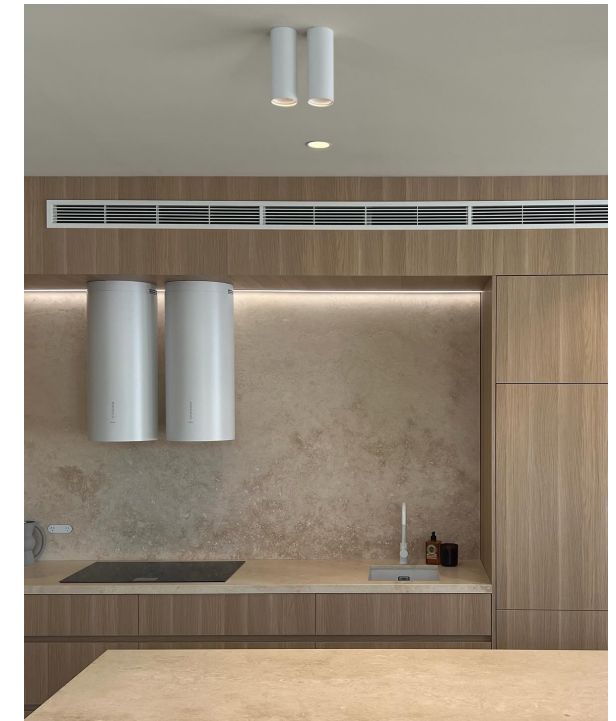



Nella Aluminium

Surface Mounted Downlights

Name	Nella
Material	Aluminium
Colour	Black, White or Brass**
Colour Temp	2700K, 3000K, 4000K, 5000K, 5700K
IP Rating	IP54
IK Rating	IK08
Installation Type	Ceiling - Surface Mounted
Diffuser Type	Plastic
Lamp Base	Built in LED
Max Wattage	12w
Protection Class	240v = 1 (Requires Earth) 12v DC = 3 (No Earth Required)
Lamp Expectancy	<30,000hrs
SDCM	<3
UGR	<10
CRI	CRI>90
Dimmable	Yes - Triac (240V Models Only)
Warranty	3 Years Replacement



Product Ordering

Image	Part Number	Colour Temp	Lumens	Input Voltage	Beam Angle	Included LED	Barcode
	HV5842S-BLK-EXT	2700k 3000k 4000k 5000k 5700k	688lm 840m 916lm 931lm 1004lm	240V AC	60°	Five Colour 12w Built in LED	9350418028594
	HV5842S-BLK-EXT-12V			12V DC			9350418033031
	HV5842S-BR-EXT			240V AC			9350418043023
	HV5842S-BR-EXT-12V			12V DC			9350418043030
	HV5842S-WHT-EXT			240V AC			9350418028617
	HV5842S-WHT-EXT-12V			12V DC			9350418033048

*See Warranty Terms & Conditions for More Information

**Brass Model can only be uses indoors

Dimensions

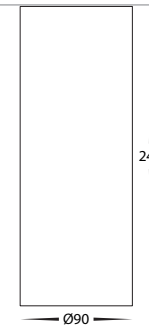

Mounting Base

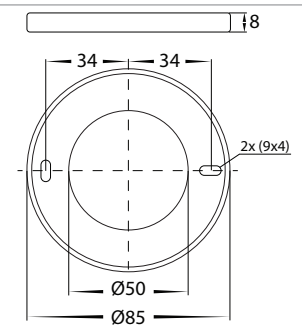

Warranty
Terms & Conditions

Website

White



Gold Insert



Black Insert



Chrome Insert

Shown with Gold Ring Attachment



Black



Gold Insert



Chrome Insert



Black Insert

Optional Compatible Havit Accessories

Image	Part Number	Description	Barcode
	HV5842-GR	Gold Insert	9350418028617
	HV5842-BR	Black Insert	9350418028624
	HV5842-CR	Chrome Insert	9350418028631
	HV9625	Triac Dimmer	9350418001795
	HV5842-BLK-PDT	3M Pendant Accessory	9350418035714
	HV5842-WHT-PDT	3M Pendant Accessory	9350418035721
	HV58103-GR	Optional gold ring to suit	9350418037305



HV5842-BLK-PDT
3M Pendant Accessory



When PDT Accessory is used, Fitting becomes IP20



HV5842-WHT-PDT
3M Pendant Accessory



Pendant Line Drawing

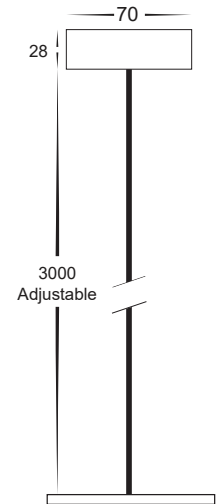

Compatible Drivers for 12v DC Models

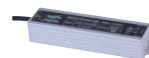

12v DC
LED Drivers

See Catalogue or Website for full range of
12v DC LED Drivers



Compatible
Drivers



Warranty
Terms & Conditions



Website