

Split Inground Light Installation Instructions

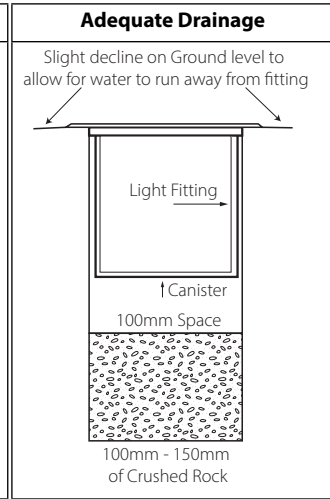

Product Specifications		
Model No.	HV1843T	HV1843RGBW
Name	Split	
Material	316 Stainless Steel	
Colour	Stainless Steel	
IP Rating	IP67	
Input Voltage	12v DC	
Protection Class	⚡ (Low Voltage)	
Lamp Base	Built In LED	
Lamp Wattage	1x 12w	
Colour Temp	TRI Colour - 3000k, 4000k, 5500k	RGBW (RGB + 3000K)
Lumens	900lm, 1030lm, 1200lm	415lm (3000k)
CRI	> 80	
Wiring	Parallel	
Dimmable	No	Yes with RGBW Controller
Warranty	3 Years Replacement*	

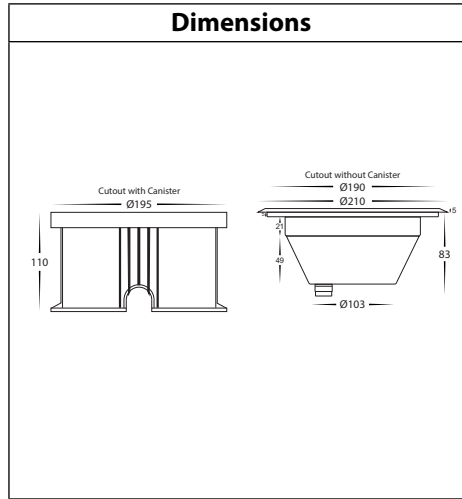

Important Safety Issues:

- This product must be installed by a qualified electrician according to AS/NZS 3000.
- Ensure all electrical mains are disconnected before any installation.
- Modification of this product will void any warranty.
- Havit Lighting does not take responsibility for wrong installation, incorrect use, or use of installation material that does not belong to the system.
- When installing low voltage fittings, Voltage to fitting must be within +or- 5% of voltage required, if not within this allowance warranty will be voided.
- Aluminium and 304SS fittings must not be installed within 5km of any salt water environments.
- All 316 stainless steel fittings must have regular cleaning maintenance to avoid any tea staining from forming on fitting. (Warranty does not cover Tea Staining)
- All o-rings and seals must be in place correctly to maintain warranty
- When installing inground light fittings, Adequate drainage must be allowed to prevent fittings from sitting in water for a long period of time, if no drainage is allowed, Warranty will be voided, See sample adequate drainage diagram for correct installation method.
- This form may be updated at any time due to product improvements, please check online installation form for most current version.

Steps for Installation: HV1843T

1. Make sure that the electrical circuit is free of voltage (master switch off)
2. Make a hole where fitting is to be placed using dimensions provided on line drawings, making sure adequate drainage is allowed.
3. Insert canister, and ensure that the top is level with ground or floor. Failure to do so will void warranty.
4. Using an appropriate 12v DC LED Driver - DO NOT CONNECT LIGHT FITTING DIRECTLY TO 240V
5. Connect the cable - If more than one fitting installed, wiring must be done in parallel.
6. Strip back the cable on both fitting and cable run and twist the positive cables together. Then connect neutral cables together
7. Solder all joins using solder and either a heat gun or butane gas torch.
8. Cover connections using an adhesive lined heat shrink or gel cap to make connection watertight. Failure to do this will void warranty.
9. Heat the heat shrink or crimp the gel cap making sure all connections are covered.
10. Make sure the seals are still in place and screws are tight to avoid any water penetration.
11. Fitting is preset to 3000k, locate cap on bottom of fitting and remove by twisting anti clockwise, Slide switch to desired colour temperature, Reattach cap making sure it is tight.
12. Insert fitting into canister.
13. Apply silicon around edge of fitting to prevent any water from getting inside to electrical connections.
14. All connections must be carried out carefully, inspect all contacts before switching back on the electric circuit.

Steps for Installation: HV1843RGBW

1. Make sure that the electrical circuit is free of voltage (master switch off)
2. Make a hole where fitting is to be placed using dimensions provided on line drawings, making sure adequate drainage is allowed.
3. Insert canister, and ensure that the top is level with ground or floor. Failure to do so will void warranty.
4. Connect the cable -
5. Use an appropriate 12v DC LED Driver and RGBW LED Controller- DO NOT CONNECT LIGHT FITTING DIRECT TO 240V
6. Do this by stripping back the cable on both fitting and cable run and twist cable together making sure all colours are correctly joined to the correct colour-
 - Black= Positive
 - Red = Red
 - Green = Green
 - Blue = Blue
 - White = White
7. Solder all joins using solder and either a heat gun or butane gas torch.
8. Cover connections using an adhesive lined heat shrink or gel cap to make connection watertight. Failure to do this will void warranty.
9. Heat the heat shrink or crimp the gel cap making sure all connections are covered.
10. Connect cable run to RGBW Controller.
11. Connect the RGBW Controller to 12v DC LED Driver.
12. Apply silicon around edge of fitting to prevent any water from getting inside to electrical connections.
13. All connections must be carried out carefully, inspect all contacts before switching back on the electric circuit.

Steps for Installation: HV1843-F-SH

1. Remove nuts on back of fitting and set aside
2. Remove cover and replace with security face
3. Reattach nuts and tighten making sure seals are still in place
4. Insert fitting into canister
5. Insert screws and tighten

Must be installed by a licensed electrician

Contact Details:

143 Beauchamp Road
Matraville NSW 2036
Australia

Tel: 02 9381 8300
Fax: 02 9666 8881
Email: sales@havit.com.au
Web: www.havit.com.au

Warranty Terms & Conditions*

Additional Information