

13W DIM TO WARM RECESSED LED DOWNLIGHTS

Web: www.havitcommercial.com.au
 Email: sales@havitcommercial.com.au
 Phone: 02 9381 8383

ADDRESS: 8/133 Beauchamp Road, Matraville, N.S.W., 2036



Warranty T & Cs



Website



PRODUCT SPECIFICATIONS	
MATERIAL	ALUMINIUM
COLOUR / FINISH	BLACK OR WHITE
INSTALLATION TYPE	CEILING - RECESSED
CUT OUT	Ø90MM
COLOUR TEMP	2000K - 3000K (DIM TO WARM)
LUMENS	844LM
INPUT VOLTAGE	240V (SUPPLIED WITH FLEX & PLUG)
PROTECTION CLASS	2 (NO EARTH REQUIRED)
LAMP BASE	BUILT IN LED
MAX WATTAGE	13W
DIMMING	TRIAC OR DALI 2
CRI	95+
BEAM ANGLE	60° (OTHER BEAM ANGLES AVAILABLE)
IP RATING	IP44
IK RATING	IK02
LAMP EXPECTANCY	>50,000HRS*
SDCM	<3
UGR	<25
IC RATING	IC-4
TILT	20°
WARRANTY	5 YEARS REPLACEMENT*

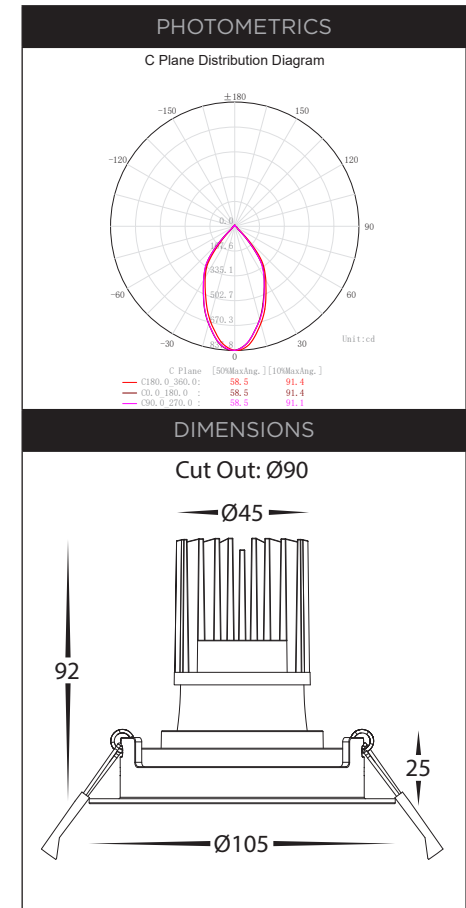

PRODUCT ORDERING

ALUMINIUM BLACK						
	HCP-81228053	2000K - 3000K	844LM	13W BUILT IN LED	TRIAC DIMMABLE	9350418096241
	HCP-81248053				DALI DIMMABLE	9350418096548
ALUMINIUM WHITE						
	HCP-81328053	2000K - 3000K	844LM	13W BUILT IN LED	TRIAC DIMMABLE	9350418096395
	HCP-81348053				DALI DIMMABLE	9350418096692

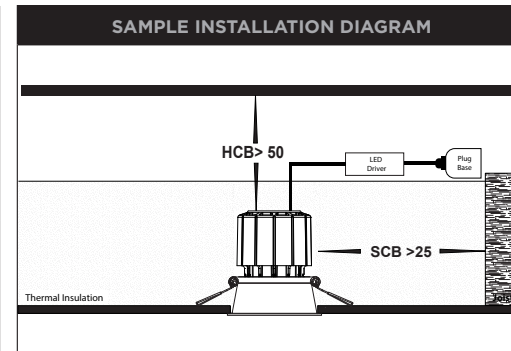

OPTIONAL REFLECTORS

	HCP-80091-15	15 Degrees
	HCP-80091-25	25 Degrees
	HCP-80091-38	38 Degrees

*See Warranty Terms & Conditions for More Information