

9W 5 COLOUR MINI RECESSED LED DOWNLIGHTS

Web: www.havitcommercial.com.au
 Email: sales@havitcommercial.com.au
 Phone: 02 9381 8383

ADDRESS: 8/133 Beauchamp Road, Matraville, N.S.W., 2036



Warranty T & Cs



Website



PRODUCT SPECIFICATIONS

MATERIAL	ALUMINIUM
COLOUR / FINISH	BLACK OR WHITE
INSTALLATION TYPE	CEILING - RECESSED
CUT OUT	Ø58MM
COLOUR TEMP	5 COLOUR - 2700K 3000K 4000K 5000K 5700K
LUMENS	750LM 760LM 785LM 800LM 805LM
INPUT VOLTAGE	240V (SUPPLIED WITH FLEX & PLUG)
PROTECTION CLASS	2 (NO EARTH REQUIRED)
LAMP BASE	BUILT IN LED
MAX WATTAGE	9W
DIMMING	TRIAC OR DALI 2
CRI	90+
BEAM ANGLE	50°
IP RATING	IP44
IK RATING	IK02
LAMP EXPECTANCY	>50,000HRS*
SDCM	<3
UGR	<19
IC RATING	IC-4
DIFFUSER TYPE	PC
TILT	NO TILT
WARRANTY	5 YEARS REPLACEMENT*



PHOTOMETRICS

LUMINOUS INTENSITY DISTRIBUTION DIAGRAM

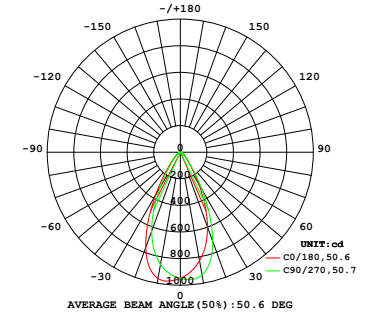

DIMENSIONS

Cut Out: Ø58

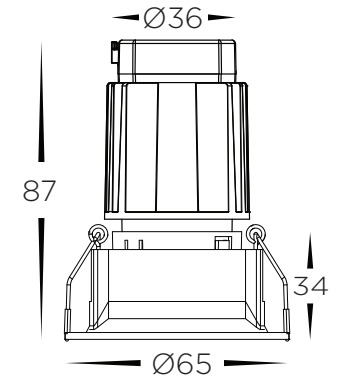

PRODUCT ORDERING

ALUMINIUM BLACK						
	HCP-81227409	2700K 3000K 4000K 5000K 5700K	750LM 760LM 785LM 800LM 805LM	5 COLOUR 9W BUILT IN LED	TRIAC DIMMABLE	9350418095558
	HCP-81247409				DALI DIMMABLE	9350418095657
ALUMINIUM WHITE						
	HCP-81327409	2700K 3000K 4000K 5000K 5700K	750LM 760LM 785LM 800LM 805LM	5 COLOUR 9W BUILT IN LED	TRIAC DIMMABLE	9350418095602
	HCP-81347409				DALI DIMMABLE	9350418095701

SAMPLE INSTALLATION DIAGRAM

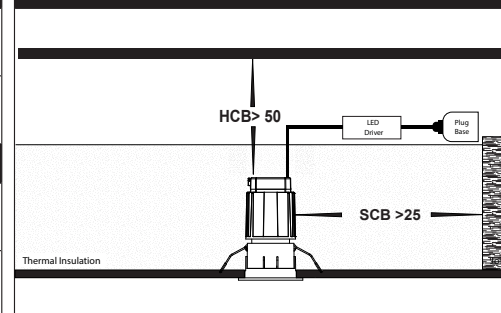

OPTIONAL HONEYCOMB LENS



*See Warranty Terms & Conditions for More Information