

CRI97+ Recessed Downlight Installation Instructions

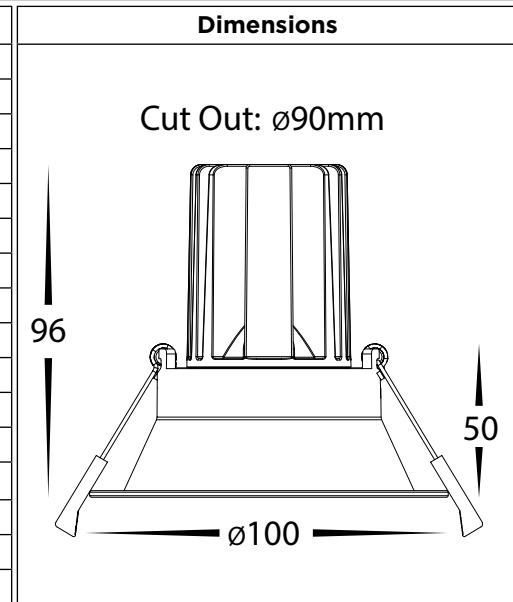

Product Specifications				
Model No.	HCP-81220483	HCP-81320483	HCP-81240483	HCP-81340483
Material	Aluminium + Plastic			
Colour	Black	White	Black	White
Installation Type	Ceiling - Recessed			
IP Rating	IP54 - Front of Fitting Only			
Cut Out	Ø90mm	Ø90mm	Ø90mm	Ø90mm
Tilt	No			
Input Voltage	240v (Remote Driver)			
Protection Class	2 (No Earth Required) <input type="checkbox"/>			
Lamp Base	Built in LED			
Lamp Wattage	1x 13w			
Colour Temp	3000k			
Lumens	939lm			
CRI	> 97			
Dimmable	Triac Dimmable		Dali 2 Dimmable	
Warranty	5 Years Replacement*			



Important Safety Issues:

- This product must be installed by a qualified electrician according to AS/NZS 3000.
- Ensure all electrical mains are disconnected before any installation.
- Modification of this product will void any warranty.
- Only LED Fitting can be installed under insulation, LED Driver must not be covered to allow for ventilation.
- This fixture must not be installed with loose fill insulation such as macerated paper and wool. LED driver must be mounted above any insulation covering the fixture.
- Havit Commercial does not take responsibility for wrong installation, incorrect use, or use of installation material that does not belong to the system.
- Aluminium and 304SS fittings must not be installed within 5km of any salt water environments.
- All o-rings and seals must be in place correctly to maintain warranty
- This form may be updated at any time due to product improvements, please check online installation form for most current version.

Steps for Installation:

1. Make sure that the electrical circuit is free of voltage (master switch off)
2. Cut out hole using dimensions in table and on line drawings above for model purchased making sure each hole is not under joist or pipes.
3. Fitting is provided with flex and plug, Plug cable into plug base installed earlier.
4. For Dali models connect Dali Cable.
5. Before installing downlight, Make sure LED Driver is not covered by any insulation.
6. Pull back springs on fitting and insert into hole.
7. Once fitting is in hole, release clips, These springs will hold fitting in place.
8. All connections must be carried out carefully, inspect all contacts before switching back on the electric circuit.

Sample Installation Diagram:

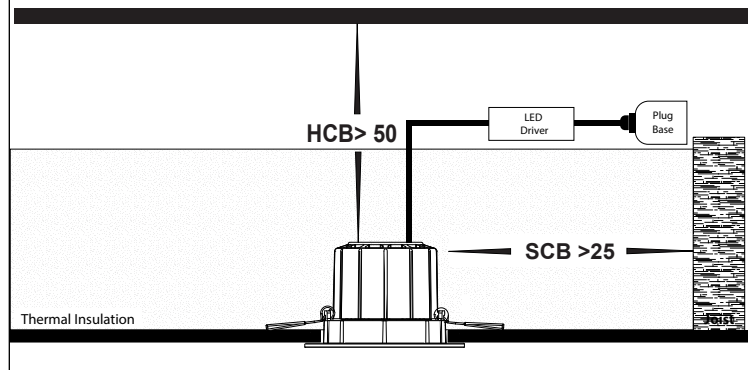

Must be installed by a licensed electrician

Contact Details:

8/133 Beauchamp Road
Matraville NSW 2036
Australia
Tel: 02 9381 8383
Email: sales@havitcommercial.com.au
Web: www.havitcommercial.com.au

Warranty Terms & Conditions*



www.havitcommercial.com.au

