

# BLACK MODULAR PROLINE LINEAR PENDANTS OR SURFACE MOUNT

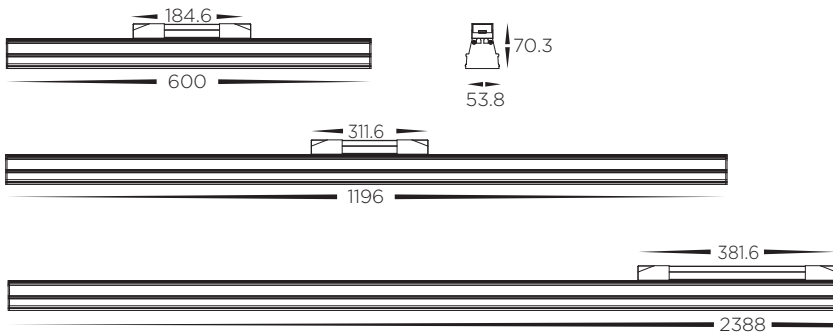

## GRILL DIFFUSER

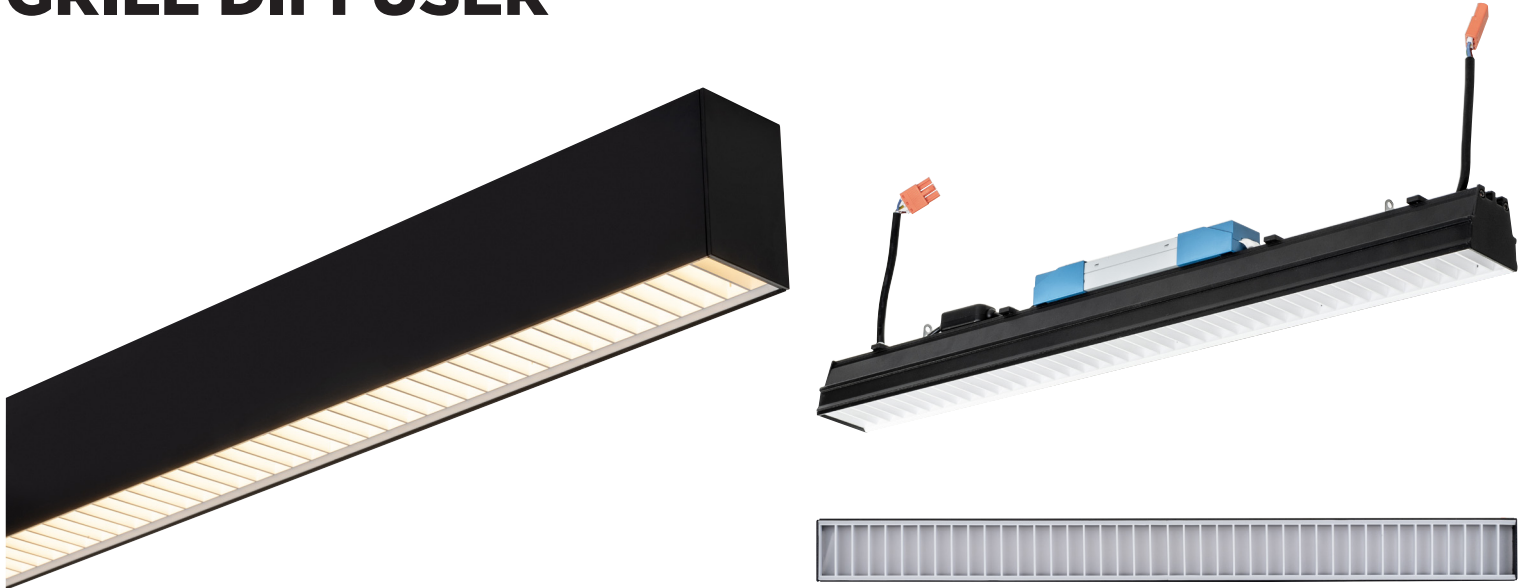

TRI Colour Switch on back of Fitting

GRILL DIFFUSER LINEAR MODULES	
MATERIAL	ALUMINIUM (AL6063-T5)
COLOUR / FINISH	MATT BLACK (RAL9005)
COLOUR TEMP	3000K   4300K   6500K
INPUT VOLTAGE	240V AC
DIMMING	TRIAC, 0-1/10V
AVAILABLE WATTAGES	17W   34W   68W
TOTAL AMPS	17W - 0.45A   34W - 0.9A   68W - 1.8A
CRI	RA >90
BEAM ANGLE	70°
UGR	<19
SDCM	<3
IP RATING	IP20
WARRANTY	5 YEARS REPLACEMENT

600MM - SPECIAL ORDER (8-12 WEEKS)				
HCP-602050-600	17W LED	3000K 4300K 6500K	720LM 970LM 820LM	TRIAC + 0-1/10V
1196MM - SPECIAL ORDER (8-12 WEEKS)				
HCP-602050-1200	34W LED	3000K 4300K 6500K	1490LM 1740LM 1600LM	TRIAC + 0-1/10V
2388MM - SPECIAL ORDER (8-12 WEEKS)				
HCP-602050-2400	68W LED	3000K 4300K 6500K	2970LM 3480LM 3190LM	TRIAC + 0-1/10V
DALI CONVERSION RELAY MODULE				
	HCP-79273	NON DIMMABLE	MAX LOAD 200W	
	HCP-79274	DIMMABLE	MAX LOAD 200W	



Web: [www.havitcommercial.com.au](http://www.havitcommercial.com.au)  
 Email: [sales@havitcommercial.com.au](mailto:sales@havitcommercial.com.au)  
 Phone: 02 9381 8383

ADDRESS: 8/133 Beauchamp Road, Matraville, N.S.W., 2036



Warranty Terms & Conditions



[www.havitcommercial.com.au](http://www.havitcommercial.com.au)

**L | T | X SHAPE CONNECTORS**

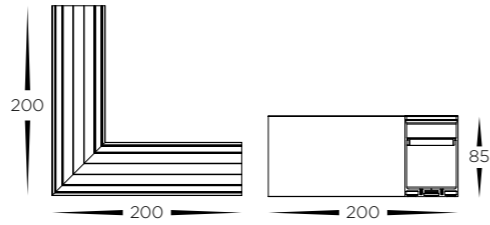
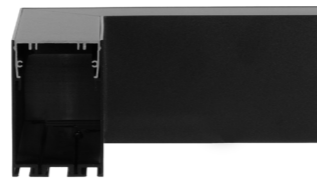

L-SHAPE CONNECTOR	
HCP-602100-L	L Shape Connector Use to make Corner with Linear Modules Supplied with Joiners IP rating: IP20

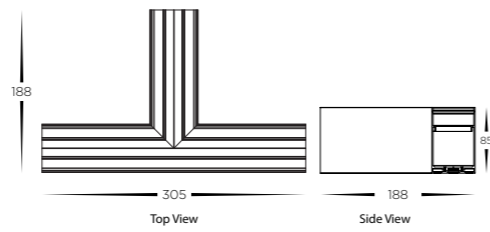

T-SHAPE CONNECTOR	
HCP-602100-T	T Shape Connector Use to make T Shape with Linear Modules Supplied with Joiners IP rating: IP20

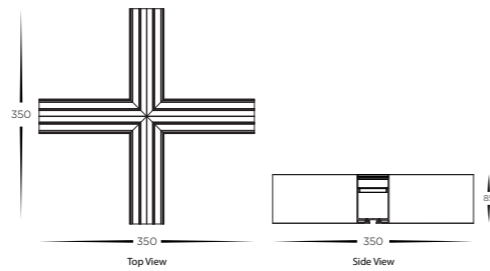
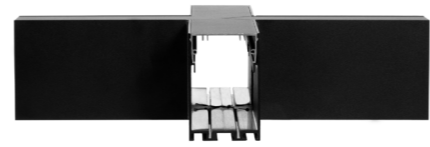
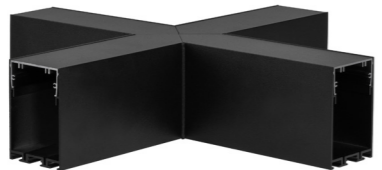

X-SHAPE CONNECTOR	
HCP-602100-X	X Shape Connector Use to make X Shape with Linear Modules Supplied with Joiners IP rating: IP20

**EXAMPLE CONFIGURATIONS**

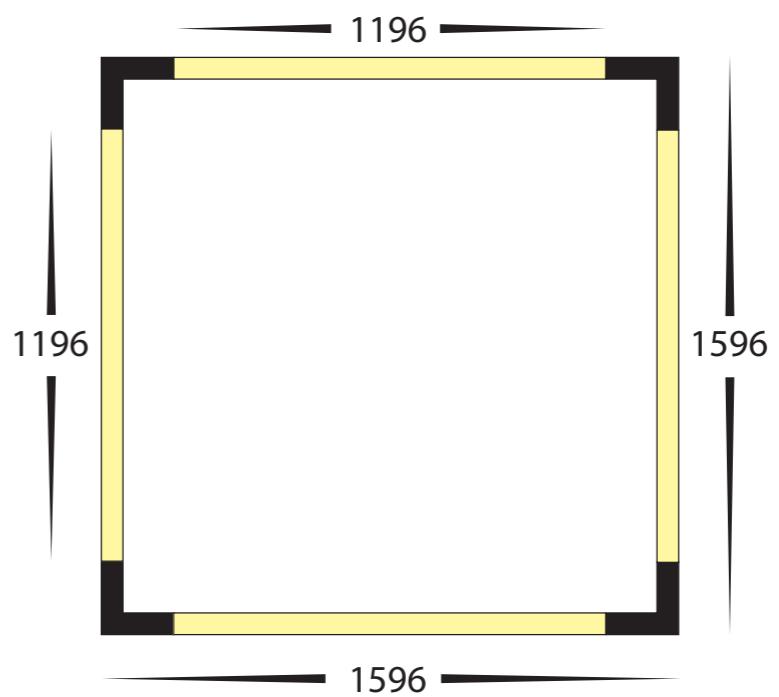
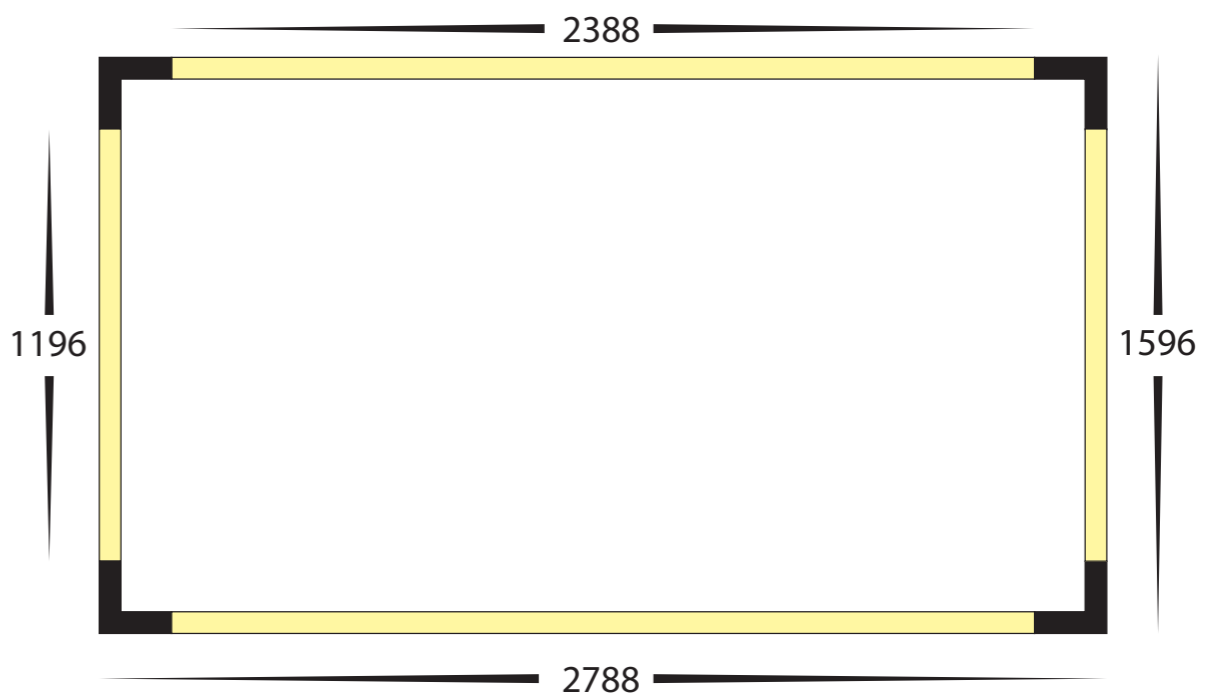

Maximum Run from Single Power Feed



# BLACK MODULAR PROLINE LINEAR PENDANTS OR SURFACE MOUNT



# BLACK MODULAR PROLINE LINEAR PENDANTS OR SURFACE MOUNT



## ACCESSORIES

ALUMINIUM CHANNEL		
	HCP-602100-2.5M	Black 56x85mm Aluminium Channel to suit Modular Fittings - 2500mm Length
	HCP-602100-PM	Black 56x85mm Aluminium Channel to suit Modular Fittings - Per Metre
END CAPS		
	HCP-602100-EC	Black End Caps to suit - Supplied in Pairs
ALUMINIUM CHANNEL COVER		
	HCP-602100-IA2.5M	Black 53.8x22.8mm Aluminium Cover to suit Modular Fittings - 2500mm Length
	HCP-602100-IAPM	Black 53.8x22.8mm Aluminium Cover to suit Modular Fittings - Per Metre
SUSPENSION KIT		
	HCP-602100-SUS	Black Suspension Kit to suit Modular Aluminium Channel - 2x 4m
MOUNTING CLIPS		
	HCP-602100-MC	Mounting Clip to suit Black 56x85mm Aluminium Channel
CANOPIES		
	HCP-602100-CPYSUS	Black Suspension Kit including canopy to suit Modular Aluminium Channel - 4m Length

## ACCESSORIES CONTINUED.

SURFACE MOUNT CLIPS		
	HCP-602100-SM	Surface Mount kit to suit Black 56x85mm Aluminium Channel
JOINER		
	HCP-602100-JOINER	Joiner to suit Black 56x85mm Aluminium Channel to suit Modular Fittings
JOINING CABLES		
	HCP-602100-1MCABLE	1 Metre Joining cable to extend cable lengths between modules
	HCP-602100-2MCABLE	2 Metre Joining cable to extend cable lengths between modules
JOINER		
	HCP-602100-POWERCABLE	Power Connection Cable to connect 1st module to existing Power
SUSPENSION RODS		
	HCP-602100-1MROD	Black 0.5-1m Adjustable Rod to suit Modular Aluminium Channel
	HCP-602100-2MROD	Black 1-2m Adjustable Rod to suit Modular Aluminium Channel
MICROWAVE SENSOR		
	HCP-602100-MSENS	Microwave Sensor for Linear Modules Aluminium black finish IP rating: IP20 Output: Max 800w Hold Time: 5s   30s   90s   5min   20min   30min Detection Area: 4-6 Metres (Mounting Height @ 3 Metres) Recommended Mounting Height: 2.5-6 Metres Detection Angle: 150°



Web: [www.havitcommercial.com.au](http://www.havitcommercial.com.au)  
Email: [sales@havitcommercial.com.au](mailto:sales@havitcommercial.com.au)  
Phone: 02 9381 8383

ADDRESS: 8/133 Beauchamp Road, Matraville, N.S.W., 2036



Warranty Terms & Conditions



[www.havitcommercial.com.au](http://www.havitcommercial.com.au)



Web: [www.havitcommercial.com.au](http://www.havitcommercial.com.au)  
Email: [sales@havitcommercial.com.au](mailto:sales@havitcommercial.com.au)  
Phone: 02 9381 8383

ADDRESS: 8/133 Beauchamp Road, Matraville, N.S.W., 2036



Warranty Terms & Conditions



[www.havitcommercial.com.au](http://www.havitcommercial.com.au)