

BLACK MODULAR PROLINE LINEAR PENDANTS OR SURFACE MOUNT

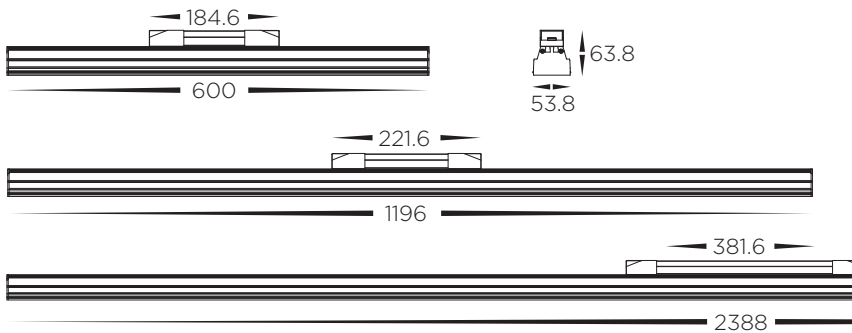

STANDARD DIFFUSER

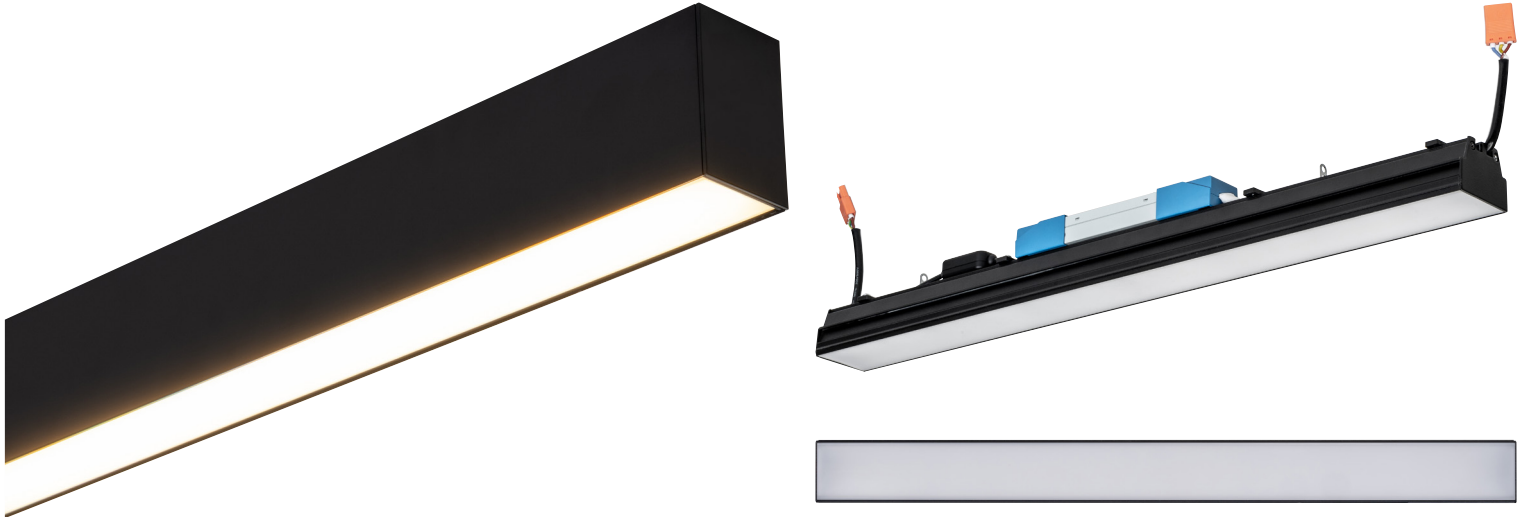

TRI Colour Switch on back of Fitting

STANDARD DIFFUSER LINEAR MODULES	
MATERIAL	ALUMINIUM (AL6063-T5)
COLOUR / FINISH	MATT BLACK (RAL9005)
COLOUR TEMP	3000K 4300K 6500K (TRI COLOUR)
INPUT VOLTAGE	240V AC
DIMMING	TRIAC, 0-1/10V
AVAILABLE WATTAGES	17W 34W 68W
TOTAL AMPS	17W - 0.45A 34W - 0.9A 68W - 1.8A
CRI	RA >90
BEAM ANGLE	120°
UGR	<24
SDCM	<3
IP RATING	IP20
WARRANTY	5 YEARS REPLACEMENT

600MM				
HCP-602010-600	17W LED	3000K 4300K 6500K	1510LM 1600LM 1523LM	TRIAC + 0-1/10V
1196MM				
HCP-602010-1200	34W LED	3000K 4300K 6500K	3014LM 3190LM 3045LM	TRIAC + 0-1/10V
2388MM				
HCP-602010-2400	68W LED	3000K 4300K 6500K	6035LM 6380LM 6090LM	TRIAC + 0-1/10V
DALI CONVERSION RELAY MODULE				
	HCP-79273	NON DIMMABLE	MAX LOAD 200W	
	HCP-79274	DIMMABLE	MAX LOAD 200W	



Web: www.havitcommercial.com.au
 Email: sales@havitcommercial.com.au
 Phone: 02 9381 8383

ADDRESS: 8/133 Beauchamp Road, Matraville, N.S.W., 2036



Warranty Terms & Conditions



www.havitcommercial.com.au

L | T | X SHAPE CONNECTORS

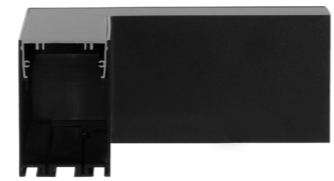
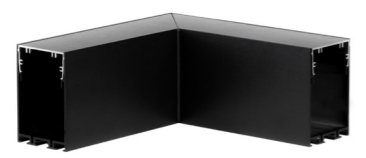

L-SHAPE CONNECTOR	
HCP-602100-L	L Shape Connector Use to make Corner with Linear Modules Supplied with Joiners IP rating: IP20

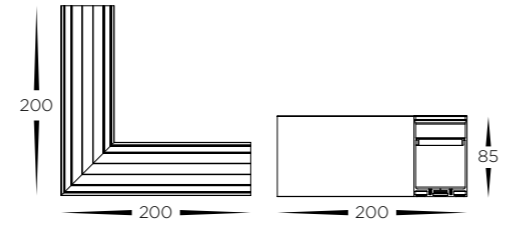

T-SHAPE CONNECTOR	
HCP-602100-T	T Shape Connector Use to make T Shape with Linear Modules Supplied with Joiners IP rating: IP20

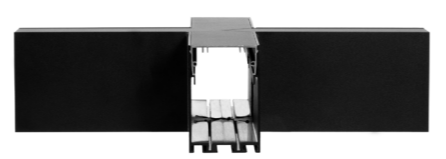
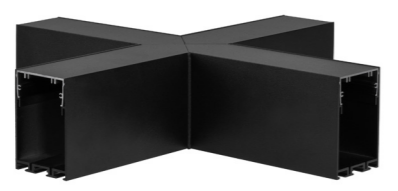
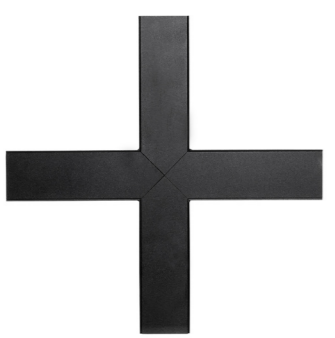
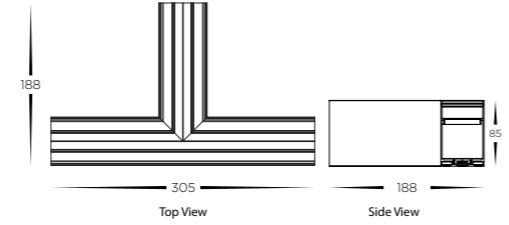

X-SHAPE CONNECTOR	
HCP-602100-X	X Shape Connector Use to make X Shape with Linear Modules Supplied with Joiners IP rating: IP20

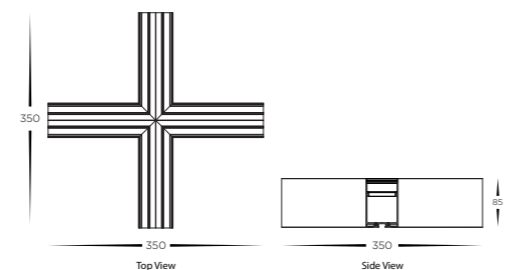

EXAMPLE CONFIGURATIONS

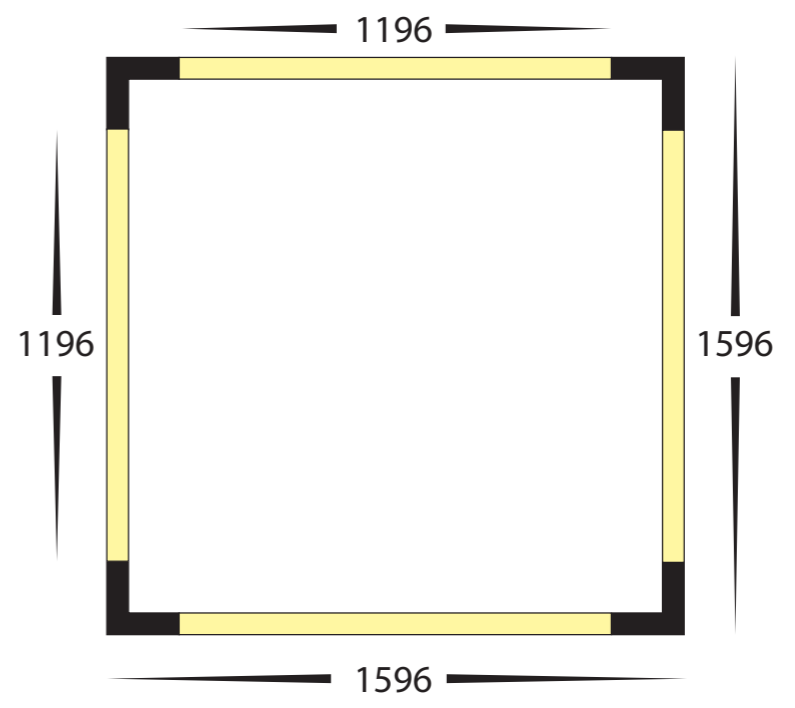
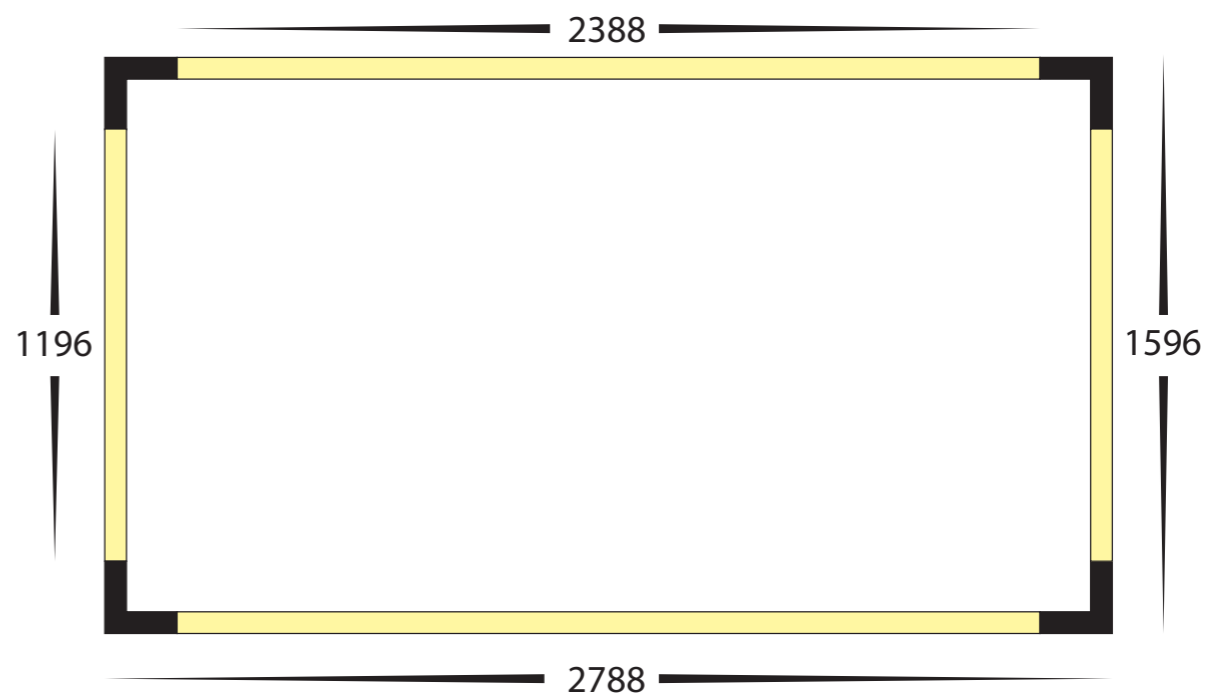

Maximum Run from Single Power Feed

23880









BLACK MODULAR PROLINE LINEAR PENDANTS OR SURFACE MOUNT



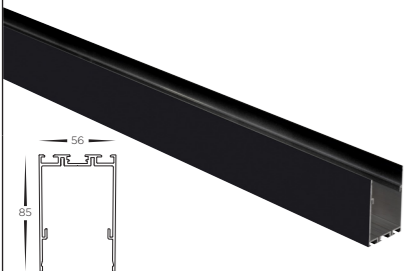

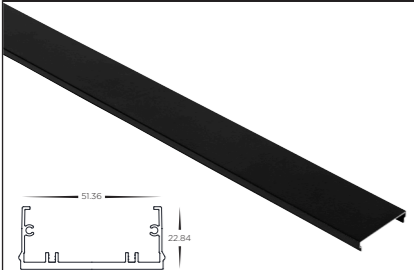

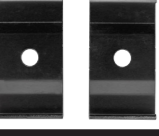

BLACK MODULAR PROLINE LINEAR PENDANTS OR SURFACE MOUNT



ACCESSORIES

ALUMINIUM CHANNEL		
	HCP-602100-2.5M	Black 56x85mm Aluminium Channel to suit Modular Fittings - 2500mm Length
	HCP-602100-PM	Black 56x85mm Aluminium Channel to suit Modular Fittings - Per Metre
END CAPS		
	HCP-602100-EC	Black End Caps to suit - Supplied in Pairs
ALUMINIUM CHANNEL COVER		
	HCP-602100-IA2.5M	Black 53.8x22.8mm Aluminium Cover to suit Modular Fittings - 2500mm Length
	HCP-602100-IAPM	Black 53.8x22.8mm Aluminium Cover to suit Modular Fittings - Per Metre
LONG RUN DIFFUSER		
	HCP-602100-SD	Standard Diffuser to suit Modular Aluminium Channel - Per Metre (Up to 20m)
SUSPENSION KIT		
	HCP-602100-SUS	Black Suspension Kit to suit Modular Aluminium Channel - 2x 4m
MOUNTING CLIPS		
	HCP-602100-MC	Mounting Clip to suit Black 56x85mm Aluminium Channel
CANOPIES		
	HCP-602100-CPYSUS	Black Suspension Kit including canopy to suit Modular Aluminium Channel - 4m Length

ACCESSORIES CONTINUED.

SURFACE MOUNT CLIPS		
	HCP-602100-SM	Surface Mount kit to suit Black 56x85mm Aluminium Channel
JOINER		
	HCP-602100-JOINER	Joiner to suit Black 56x85mm Aluminium Channel to suit Modular Fittings
JOINING CABLES		
	HCP-602100-1MCABLE	1 Metre Joining cable to extend cable lengths between modules
	HCP-602100-2MCABLE	2 Metre Joining cable to extend cable lengths between modules
JOINER		
	HCP-602100-POWERCABLE	Power Connection Cable to connect 1st module to existing Power
SUSPENSION RODS		
	HCP-602100-1MROD	Black 0.5-1m Adjustable Rod to suit Modular Aluminium Channel
	HCP-602100-2MROD	Black 1-2m Adjustable Rod to suit Modular Aluminium Channel
MICROWAVE SENSOR		
	HCP-602100-MSENS	Microwave Sensor for Linear Modules Aluminium black finish IP rating: IP20 Output: Max 800w Hold Time: 5s 30s 90s 5min 20min 30min Detection Area: 4-6 Metres (Mounting Height @ 3 Metres) Recommended Mounting Height: 2.5-6 Metres Detection Angle: 150°



Web: www.havitcommercial.com.au
Email: sales@havitcommercial.com.au
Phone: 02 9381 8383



Warranty Terms & Conditions



www.havitcommercial.com.au



Web: www.havitcommercial.com.au
Email: sales@havitcommercial.com.au
Phone: 02 9381 8383



Warranty Terms & Conditions



www.havitcommercial.com.au

ADDRESS: 8/133 Beauchamp Road, Matraville, N.S.W., 2036

ADDRESS: 8/133 Beauchamp Road, Matraville, N.S.W., 2036