

17MM X 17MM SIDE BEND HAVIFLEX INSTALLATION INSTRUCTIONS

PART NUMBER	COLOUR TEMP.
HCP-371500	RGBCW

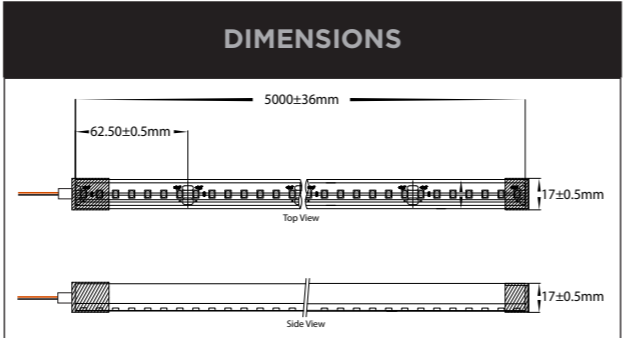

Correct Bending Methods:

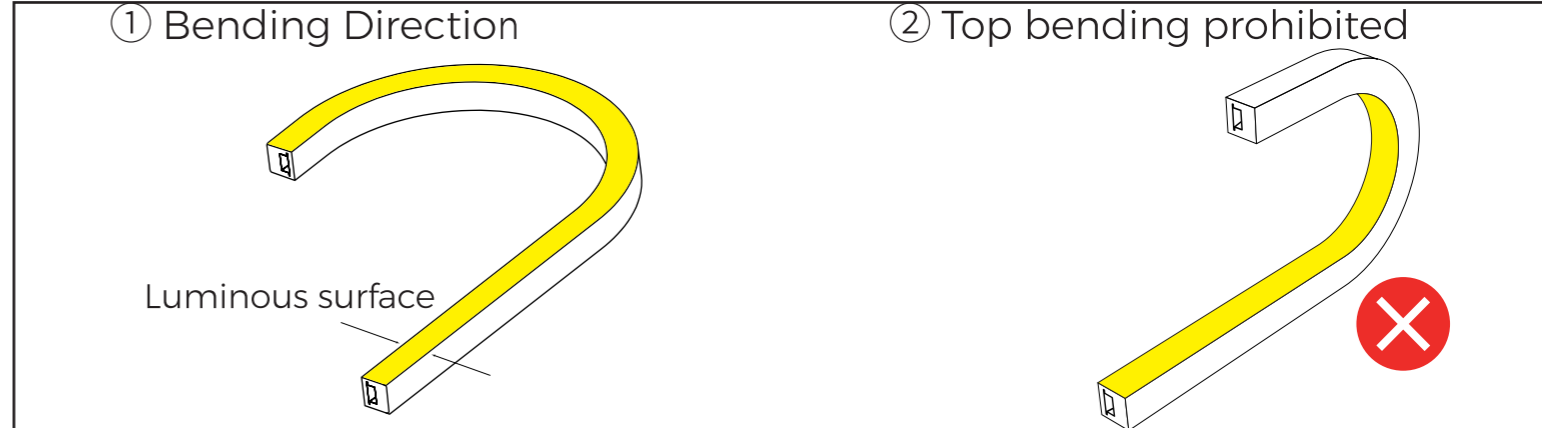

Please read the instructions carefully before installation.

Guide on accessories are included in these instructions.

After using these instructions keep them stored in a safe location as reference of all further use in the future.

Before installation connect product while uninstalled, If there is any product that is not working correctly, Please contact store where items were purchased from to work out next steps.

Do not continue to install the product.

WARNING: This product is very fragile, Any misuse or mishandling will cause product to fail and will void warranty.

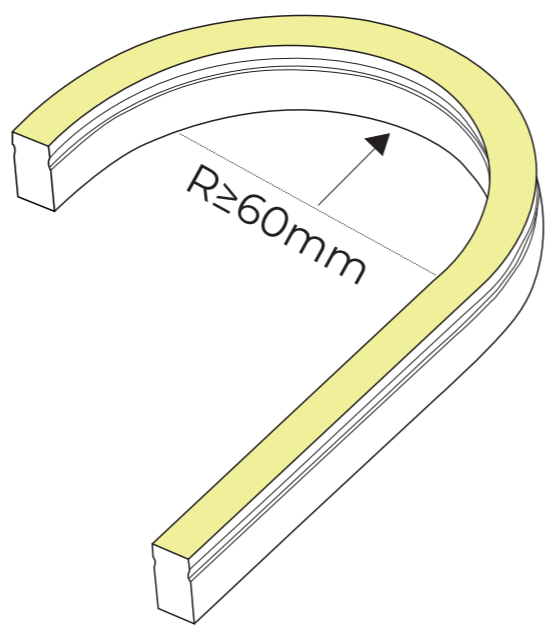

Side Bend Only

Installation Steps:

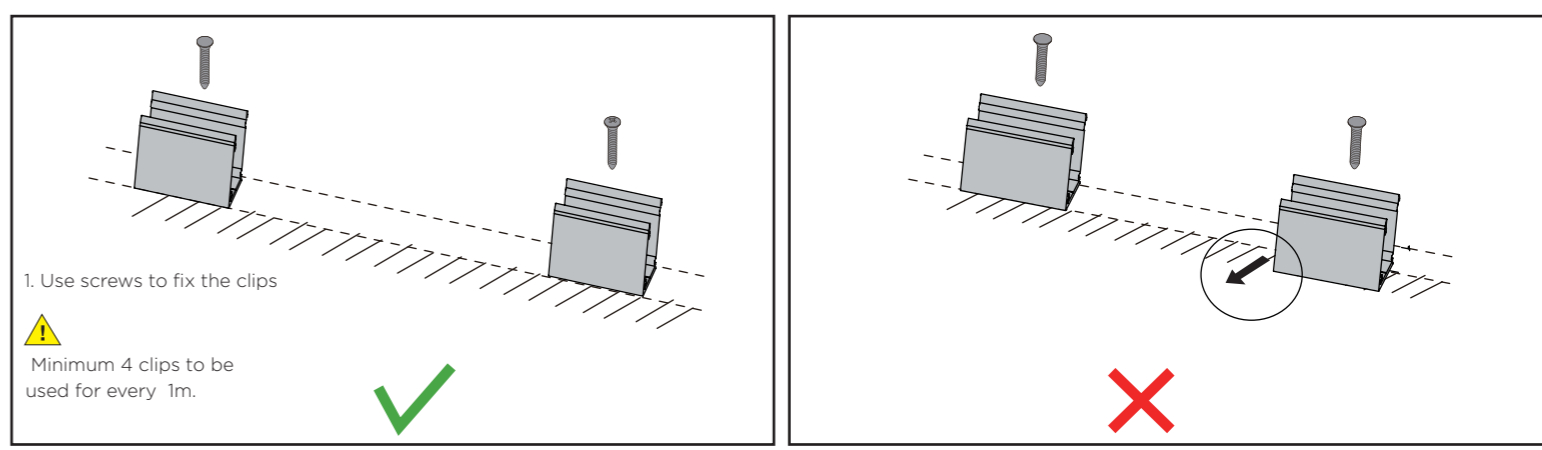

Precautions before Installation:

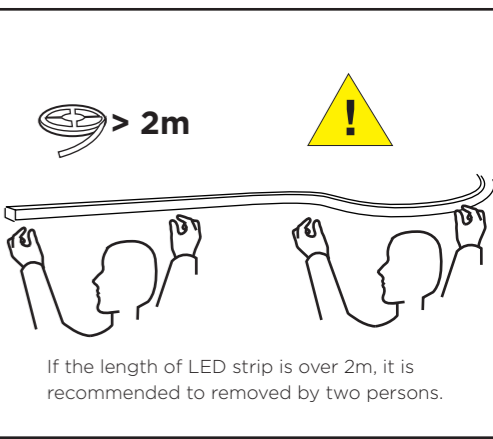
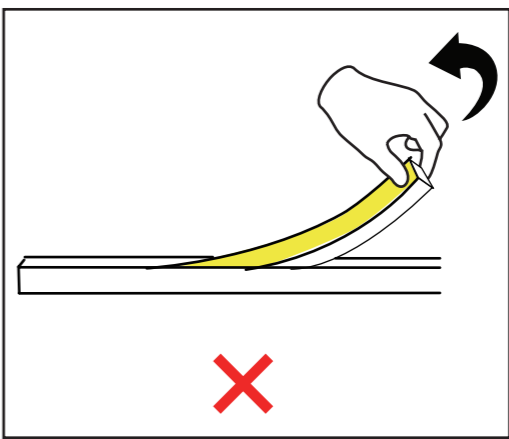
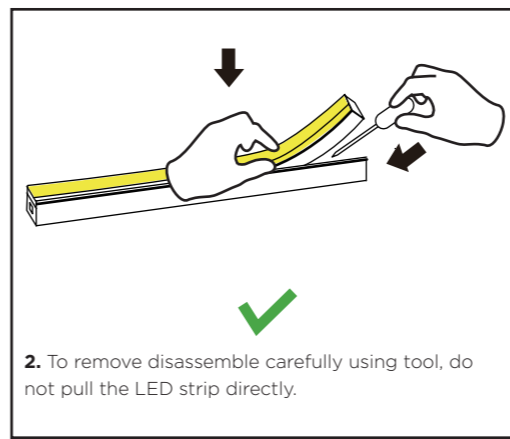
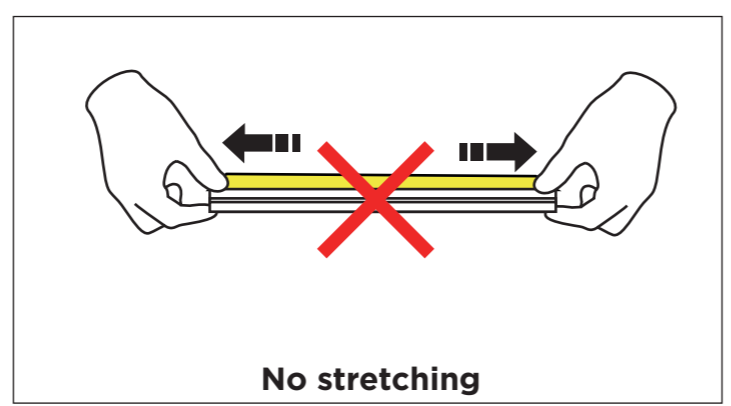
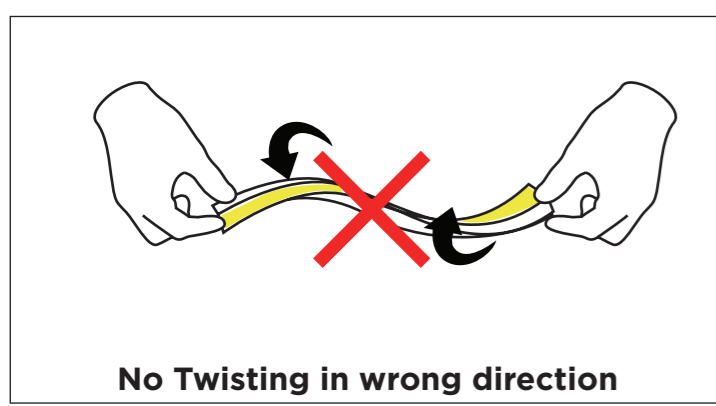
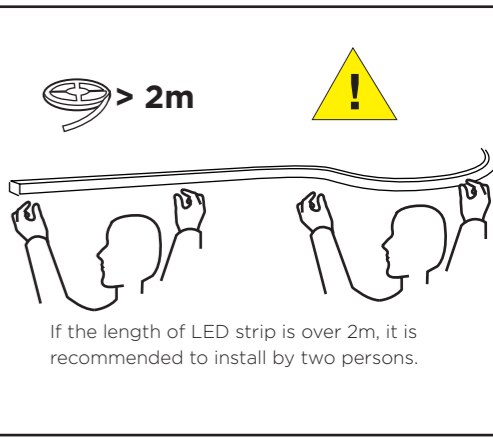
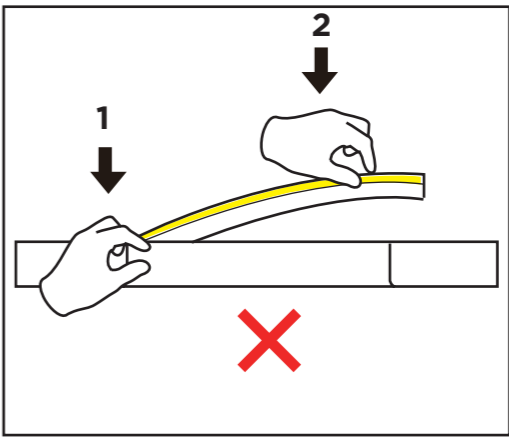
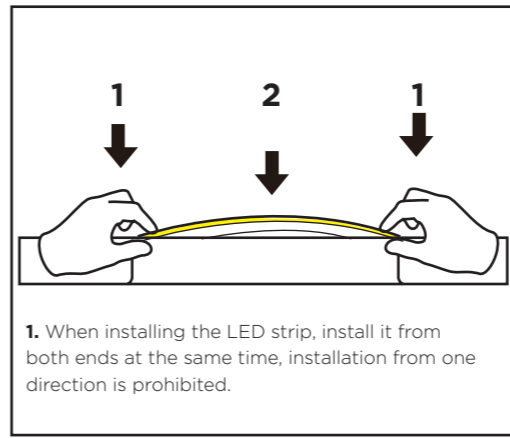
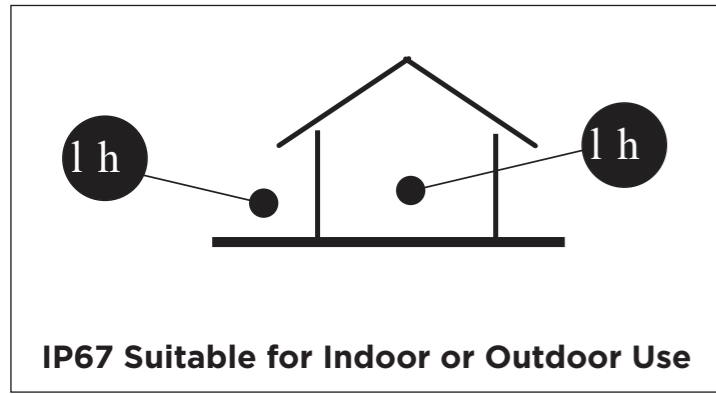

Instructions for Cutting and Soldering:

1. Cut the LED strip to required length
The minimum cutting unit should be subject to the mark of LED strip

Cutting Mark

Please note that the cutting point is visible as a hidden black mark inside the strip.

2. Cut out a piece of light strip with proper dimensions according to requirements

3. Connect the wires with the LED strip using solder and soldering iron
(pay attention to positive and negative poles)

electric soldering iron

4. Place the plug with a hole into the wires and inject Silicon into the cap.

The amount of silicon should be 1/3 to 1/2 of the Cap

Silicon

5. Push the cap onto the LED strip

Push Onto

After injecting silicon, the LED strip should be placed horizontally for two hours until the plug surface is dry, and then to finish the operation of plug end.

6. Fill the end of LED strip with filler, then push the Cap onto the end of LED strip.

Silicon

Push Onto

After injecting silicon, the LED strip should be placed horizontally for two hours until the plug surface is dry, and then to finish the operation of plug end.

Notes:

1. Only the parts with cutting marks can be cut when it is necessary to cut the silicone neon strip according to the on-site installation length;
2. Use a 24V DC isolated power supply to drive the silicone neon strip and the ripple wave of constant voltage source shall be less than 5%. It is not allowed to use RC voltage reduction or non-isolated power supply to drive the silicone neon strip.
3. When connecting multiple silicone neon strips. Wiring must be done in Parallel.
4. Attention should be paid to the positive and negative poles of the wires during installation and whether the power supply conforms to required voltages to avoid damages.
5. Silicone neon strip should be placed in a dry and sealed environment. It is suggested that the storage period cannot be too long. Working temperature: -20°C- +45°C; storage temperature: 0°C- +60°C
6. In actual applications, 20% of the power supply shall be kept (only 80% of the power is used) to guarantee that sufficient voltage is available to drive the product;
7. Attention shall be paid to safe operation. After powering on, it is not allowed to touch the AC power supply to avoid an electric shock;
8. On the premise of required direction (the top view is not same as the side view), please do not bend the strip into an arc with a diameter less than 60mm to ensure the longevity and reliability.

Product Warranty Description

1. A warranty period of Five years is provided for products in normal use. For any faults arising during the period that are confirmed to be quality related by inspection of Havit Commercial, a replacement strip will be offered.
2. The warranty does not cover any of the following:
 - (1) Any product damage due to usage not allowed in the instructions;
 - (2) Any product damage due to disassembling or wrong operations by the user;
 - (3) Severe appearance damage or deformation of the product.

Sample Wiring Diagrams

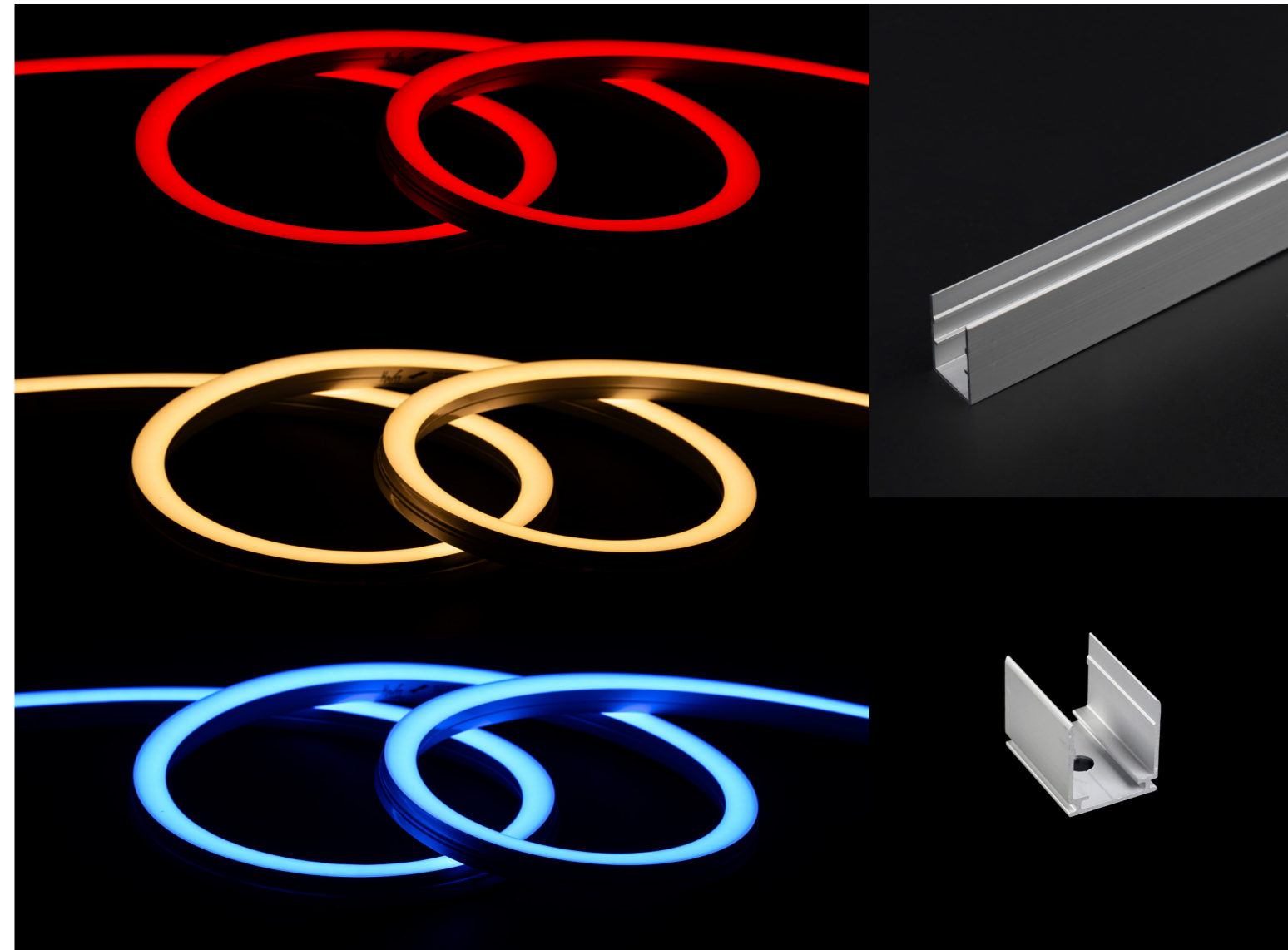
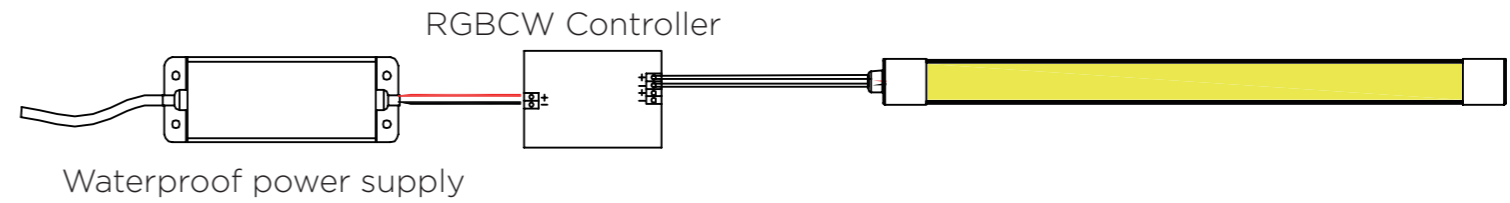

Notices

1. The products are subject to thermal expansion as a result of the changes in temperature to which they are subject. This thermal expansion must be taken into account in installations subject to a wide range of temperature.
2. Clean the Haviflex only using water and methylated spirits.
3. IP67 protection on the product and the continuous line system.
4. Product is not suitable for use in swimming pools and fountains