

LONG RUN IP67 HAVIFLEX SIDE BEND LED STRIP

Web: www.havitcommercial.com.au
Email: sales@havitcommercial.com.au
Phone: 02 9381 8383

ADDRESS: 8/133 Beauchamp Road, Matraville, N.S.W., 2036



Warranty T & Cs



Website



7.2W IP67 HAVIFLEX LED STRIP	
LED CHIP TYPE	COB
SIZE	6MM X 11MM (NOT INCLUDING END CAPS)
PCB	30Z
LED CHIPS PER METRE	120LED
CUT INCREMENTS	EVERY 50MM
COLOUR TEMP	2700K 3000K 4000K
LUMEN OUTPUT	210LM 215LM 220LM
INPUT VOLTAGE	24V DC CONSTANT VOLTAGE
WIRING	PARALLEL
MOUNTING	MOUNTING CLIPS (4 SUPPLIED PER METRE)
MAXIMUM LENGTH	15,000MM
REQUIREMENTS	24V DC CONSTANT VOLTAGE LED DRIVER
DIMMING	0-1/10V, DALI, DMX, RF, WIFI
OPERATING TEMP.	-20° TO 65° CELCIUS
AMBIENT TEMP	-20° TO 45° CELCIUS
CRI	RA >90
SDCM	<3
BEAM ANGLE	120°
IP RATING	IP67
LIFE EXPECTANCY	>50,000 HRS*
WARRANTY	5 YEARS REPLACEMENT*

PRODUCT ORDERING		
HCP-37606112	2700K	210LM
HCP-37606113	3000K	215LM
HCP-37606114	4000K	220LM



*SEE WARRANTY TERMS & CONDITIONS FOR MORE INFORMATION.

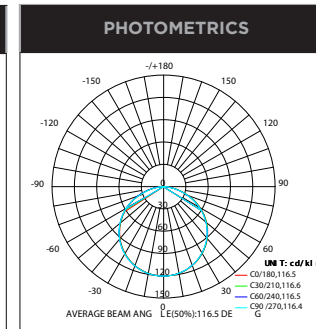
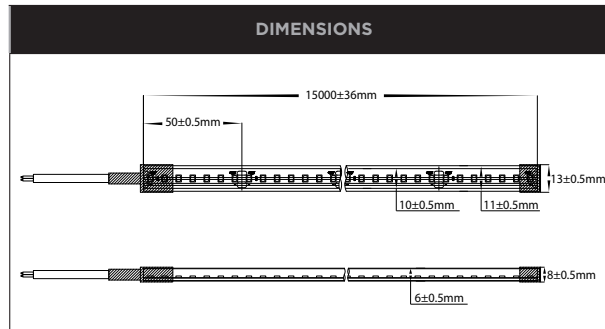
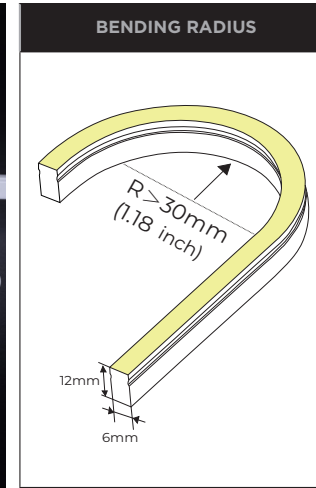

OPTIONAL HAVIT COMPATIBLE ACCESSORIES			
IMAGE	DIMENSIONS	PART NUMBER	DESCRIPTION
		HCP-3660612-AC	ALUMINIUM CHANNEL TO SUIT - PER METRE (UP TO 2M LENGTH)
		HCP-3760611-MC	MOUNTING CLIP TO SUIT (SOLD IN PAIRS)
		HCP-3660612-BC	BENDABLE CHANNEL TO SUIT (SUPPLIED AS 2X 500MM)



2700K

HCP-37606112

3000K

HCP-37606113

4000K

HCP-37606114

LONG RUN IP67 HAVIFLEX SIDE BEND LED STRIP

COMPATIBLE CONTROLLERS & DRIVERS

Web: www.havitcommercial.com.au
 Email: sales@havitcommercial.com.au
 Phone: 02 9381 8383

ADDRESS: 8/133 Beauchamp Road, Matraville, N.S.W., 2036







Warranty T & Cs







Website



EXAMPLES OF COMPATIBLE CONTROLLERS	
SINGLE COLOUR LED STRIP CONTROLLERS	
TOUCH PANEL	REMOTE CONTROLLER
 HCP-75215  HCP-75215	 HCP-72812  HCP-73211



SCAN TO EXPLORE
 FULL RANGE OF SINGLE
 COLOURED LED STRIP
 CONTROLLERS

EXAMPLES OF COMPATIBLE DRIVERS			
TRIAC	DALI 2 OR PUSH DIM	NON DIMMABLE	TRIAC + 0-1 / 10V
 HCP-51221	 HCP-522231	 HCP-52230	 HCP-52222



SCAN TO
 EXPLORE FULL
 RANGE OF LED
 DRIVERS

