

# 4-6W 2 WAY 316 STAINLESS STEEL INGROUND LIGHT

Web: [www.havitcommercial.com.au](http://www.havitcommercial.com.au)  
 Email: [sales@havitcommercial.com.au](mailto:sales@havitcommercial.com.au)  
 Phone: 02 9381 8383

ADDRESS: 8/133 Beauchamp Road, Matraville, N.S.W., 2036



Warranty T & Cs



Website



PRODUCT SPECIFICATIONS	
MATERIAL	316 STAINLESS STEEL
COLOUR / FINISH	316 STAINLESS STEEL   BLACK
COLOUR TEMP	3000K   4000K   5500K (TRI-COLOUR)
LUMENS	2x 12LM   2x 13LM   2x 19LM
INPUT VOLTAGE	12 - 24V DC
PROTECTION CLASS	3 (NO EARTH REQUIRED)
LAMP BASE	4-6W BUILT IN LED
CRI	RA >90+
DIMMING	YES - TRIAC DIMMABLE WHEN USED WITH 12V DC LED DRIVER
CABLE LENGTH	500MM
TRAFFICABLE	YES - UP TO 1,000 KGS
UGR	<10
SDCM	<3
INSTALLATION TYPE	INGROUND - RECESSED
IK RATING	IK08
BEAM ANGLE	50°
LAMP EXPECTANCY	>30000HRS*
IP RATING	IP67
WARRANTY	5 YEARS REPLACEMENT*

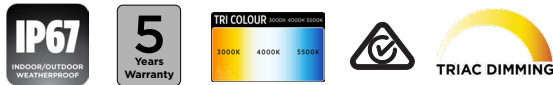
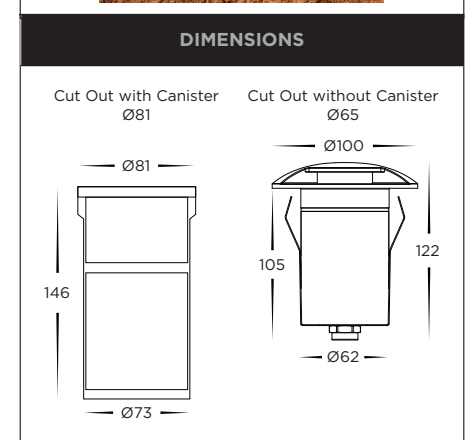
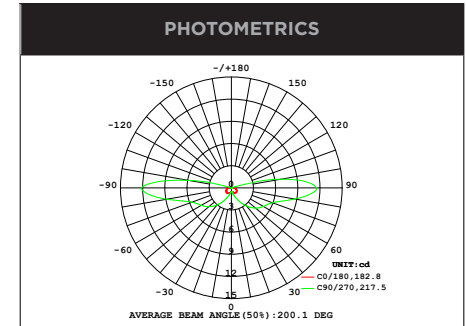
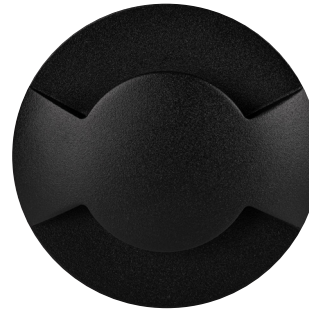
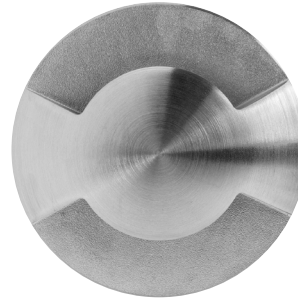

## PRODUCT ORDERING

316 STAINLESS STEEL			
	HCP-271912	3000K 4000K 5500K	2x 12LM 2x 13LM 2x 19LM
316 STAINLESS STEEL BLACK			
	HCP-272912	3000K 4000K 5500K	2x 12LM 2x 13LM 2x 19LM

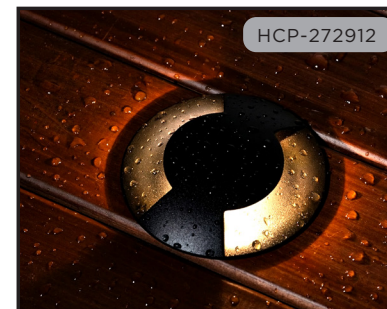
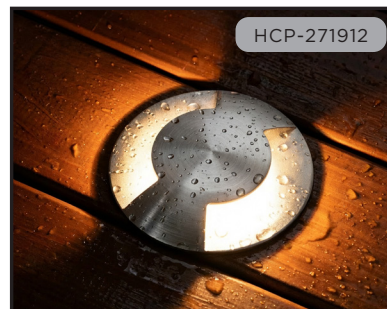

\*SEE WARRANTY TERMS & CONDITIONS FOR MORE INFORMATION