

2.5w 2 Way Deck or Inground Light Installation Instructions



Product Specifications

Model No.	HCP-271104	HCP-272104	HCP-275104	HCP-276104
Material	316 Stainless Steel	316 Stainless Steel	Solid Brass	Solid Brass
Colour	Stainless Steel	Black	Brass	Antique Brass
Cut Out	With Canister - Ø48mm			
	Without Canister - Ø43mm			
Installation Type	Ground or wall - Recessed			
Trafficable	Up to 500kgs			
IP Rating	IP67			
IK Rating	IK10			
Input Voltage	24v DC Constant Voltage - External Power Supply Required			
Protection Class	3 (no earth required) ⚡			
Wiring	Parallel			
Lamp Base	Built in LED			
Lamp Wattage	1x 2.5w			
Colour Temp	Tri Colour - 3000k, 4000k, 5500k			
Lumens	50lm, 60lm, 55lm			
CRI	90+			
Dimmable	No			
Warranty	5 Years Replacement*			

Dimensions

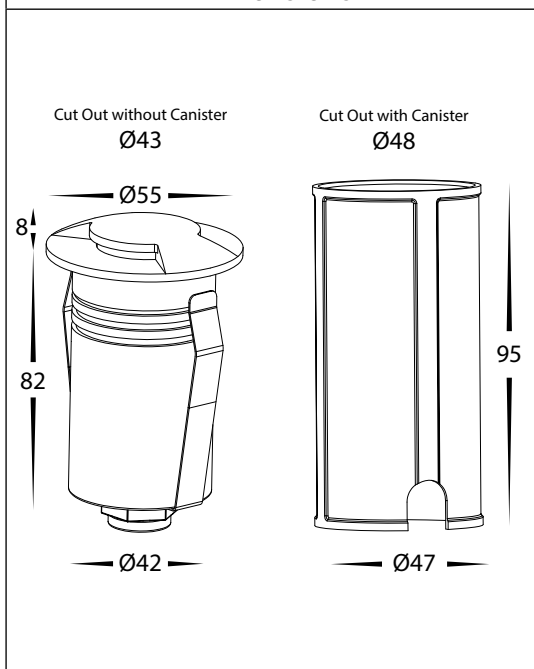

Important Safety Issues:

- This product must be installed by a qualified electrician according to AS/NZS 3000.
- Ensure all electrical mains are disconnected before any installation. Modification of this product will void any warranty.
- Havit Commercial does not take responsibility for wrong installation, incorrect use, or use of installation material that does not belong to the system.
- All electrical connections must be watertight. If a watertight connection is not done, Warranty will be voided.
- When installing low voltage fittings, Voltage to fitting must be within +or- 5% of voltage required and cannot be installed more than 25m from LED Driver, if not within this allowance warranty will be voided.
- When installing Brass fittings, gloves must be worn to avoid any oils transferring to fitting.
- When installing inground light fittings, Adequate drainage must be allowed to prevent fittings from sitting in water for a long period of time, if no drainage is allowed, Warranty will be voided, See sample adequate drainage diagram for correct installation method.
- All 316 stainless steel fittings must have regular cleaning maintenance to avoid any tea staining from forming on fitting. (Warranty does not cover Tea Staining)
- All o-rings and seals must be in place correctly to maintain warranty
- These instructions may be updated at any time due to product improvements, Please visit website for most current installation instructions.

Wiring Diagram

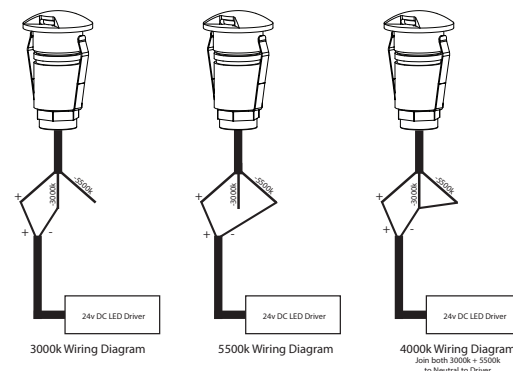

Steps for Installation:

1. Make sure that the electrical circuit is free of voltage (master switch off)
2. Make hole in desired location using measurements above in table.
3. If installing in concrete, Insert canister allowing adequate drainage (see sample diagram above), and ensure that the top is level with ground or floor. Failure to do so will void warranty.
4. Insert cables through hole ready for connection.
5. Connect the cable - If more than one fitting installed, wiring must be done in parallel.
6. Strip back the cable on both fitting and cable run and twist the positive cables together.
7. Then connect neutral cables together, Neutral cables are marked for selection of colour temperature. If 3000k or 5500k is selected you must terminate extra cable to be IP Rated to avoid any water making contact with internal parts of cable. To get 4000k, Join both 3000k + 5500k together and connect to neutral on cable run.
8. Solder all joins using solder with either a heat gun or butane gas torch.
9. Cover connections using an adhesive lined heat shrink or gel cap to make connection watertight. (failure to do this step will void warranty)
10. Push connected cables into hole and insert fitting into canister or deck. Apply silicon around edge of fitting to prevent any water from getting inside to electrical connections.
11. All connections must be carried out carefully, inspect all contacts before switching back on the electric circuit.

Adequate Drainage Diagram

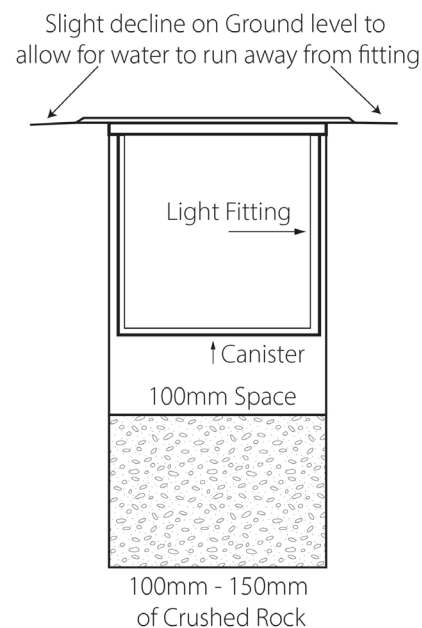

Must be installed by a licensed electrician

Contact Details:

8/133 Beauchamp Road
Matraville NSW 2036
Australia
Tel: 02 9381 8383
Email: sales@havitcommercial.com.au
Web: www.havitcommercial.com.au

Warranty Terms & Conditions*



www.havitcommercial.com.au

