

# 14.4w 12v DC IP54 2M Viper Kits



## PRODUCT SPECIFICATIONS

Name	Viper
Wattage Per Metre	14.4w
Colour Temp.	3000K, 4000K, 5500K
CRI:	>80
Beam Angle	120°
IP Rating	IP54
Size	10mm x 3mm
Dimmable	No
LED Chip Type	2835
LED Chips Per Metre	60
Supplied Length	2m
Cutting Increments	Every 50mm
Wiring	Parallel
Dimmable	No
Warranty	2 Years Replacement



## DIMENSIONS

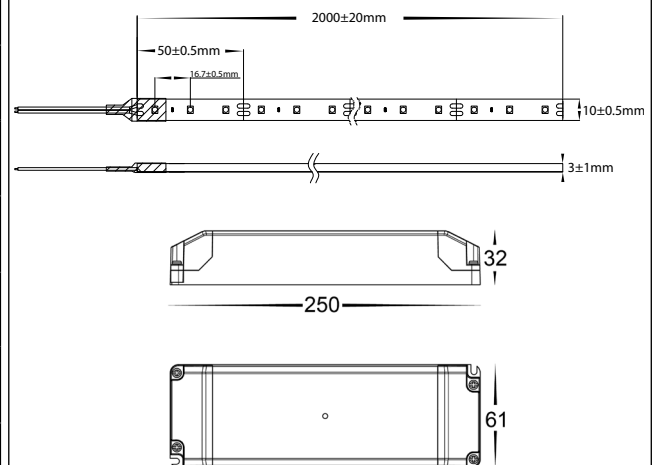

IMAGE	PART NUMBER	COLOUR TEMP	LUMENS PER METRE	INPUT VOLTAGE	INCLUDED IN KIT
	<b>VPR9783IP54-60-2M</b>	3000K	1200lm	240v AC (Driver) 12v DC (LED Strip)	2m x 3000K IP54 LED Strip + 1x 75w LED Driver
	<b>VPR9785IP54-60-2M</b>	4000K	1260lm	240v AC (Driver) 12v DC (LED Strip)	2m x 4000K IP54 LED Strip + 1x 75w LED Driver
	<b>VPR9784IP54-60-2M</b>	5500K	1320lm	240v AC (Driver) 12v DC (LED Strip)	2m x 5500K IP54 LED Strip + 1x 75w LED Driver

For More Information Contact Havit Lighting

143 Beauchamp Road  
Matraville NSW 2036  
Australia

Tel: 02 9381 8300  
Fax: 02 9666 888  
Email: sales@havit.com.au  
Web: www.havit.com.au