

30w IP20 Indoor LED Strip Driver

PRODUCT SPECIFICATIONS

- Material:** Plastic
- Colour:** White
- Input Voltage:** 240v AC
- Output Voltage:** 12v DC or 24v DC
- Output Power:** 30w*
- Wiring:** Parallel
- IP Rating:** IP20
- Dimmable:** No
- Warranty:** 2 Years Replacement**



Supplied with Flex & Plug

COMPATIBLE WITH

LED Strip

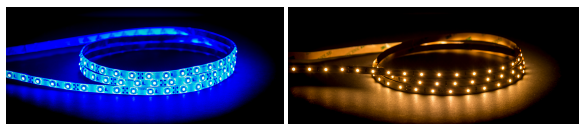

DIMENSIONS

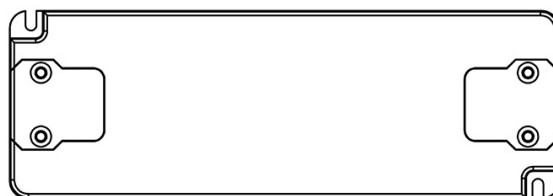
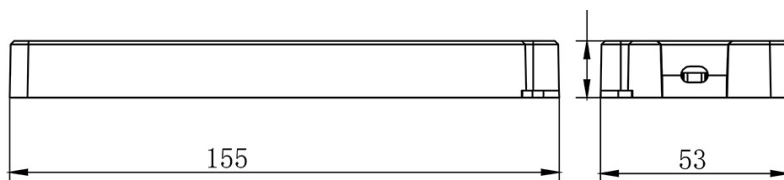

IP RATING



APPROVAL



Product Ordering

IMAGE	OUTPUT VOLTAGE	PART NUMBER
	12v DC	HV9666-12V30W
	24v DC	HV9666-24V30W

SAMPLE INSTALLATION DIAGRAM

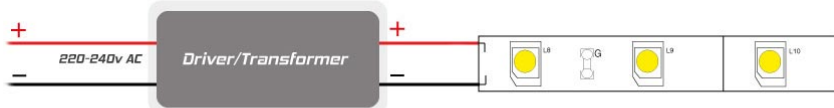

* Recommended maximum Load of 24w
 ** See Warranty Terms and Conditions for more information

For more information contact Havit Lighting

ADDRESS:
 143 Beauchamp Road
 Matraville NSW 2036
 Australia

Tel: 02 9381 8300
 Fax: 02 9666 8881
 Email: sales@havitt.com.au
 web: www.havit.com.au

Output	DC Voltage	12V	24V
	Voltage Tolerance	±0.5V	
	Voltage Regulation	± 0.5%	
	Rated current	2.5A	1.25A
	Rated power	30W	30W
Input	Voltage Range	220-240V AC	
	Frequency range	47 - 63HZ	
	Power Factor (Typ.)	PF≥0.95 (Full loading)	
	Full Load Efficiency(Typ.)	88%	89%
	AC Current(Max.)	0.20A	
	Leakage Current	<0.50mA	
Protection	Short Circuit	Hiccup mode, recovers automatically after fault condition is removed	
	Over Load	≤120% shut down o/p voltage, re-power on to recover after fault condition is removed	
	Over Temperature	100°C ± 10°C shut down o/p voltage, re-power on to recover	
	Protection Class:	II	
Environment	Working temperature	40 - +60°C	
	Working humidity	20 - 90%RH,non-condensing	
	Storage temp. and humidity	-40- + 80°C, 10-95%RH	
	Temp. coefficient	±0.03%/°C (0-50°C)	
	Vibration	10-500Hz,2G 12min./1 cycle,period for 72min.each along X.Y.Z axes.	
Safety and EMC	Safety standards	EN61347-1 EN61347-2-13 IP20	
	Withstand voltage	I/P-O/P:3.75KVAC I/P-FG:1.88KVAC O/P-FG:0.5KVAC	
	Insolation resistance	I/P-O/P I/P-FG O/P-FG:100MΩ/500VDC/25°C/70%RH	
	EMC Emission	EN55015,EN61000-3-2,3 (>60%loading)	
	EMC Immunity	EN61000-4-2,3,4,5,6,11,EN61547, A light industry level (Surge 4KV)	

20w IP20 Indoor LED Strip Driver

PRODUCT SPECIFICATIONS

- Material:** Plastic
- Colour:** White
- Input Voltage:** 240v AC
- Output Voltage:** 12v DC or 24v DC
- Output Power:** 20w*
- Wiring:** Parallel
- IP Rating:** IP20
- Dimmable:** No
- Warranty:** 2 Years Replacement**



Supplied with Flex & Plug

COMPATIBLE WITH

LED Strip

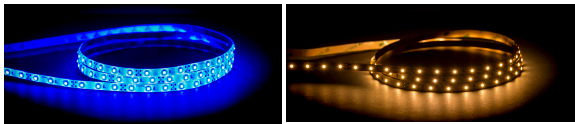

DIMENSIONS

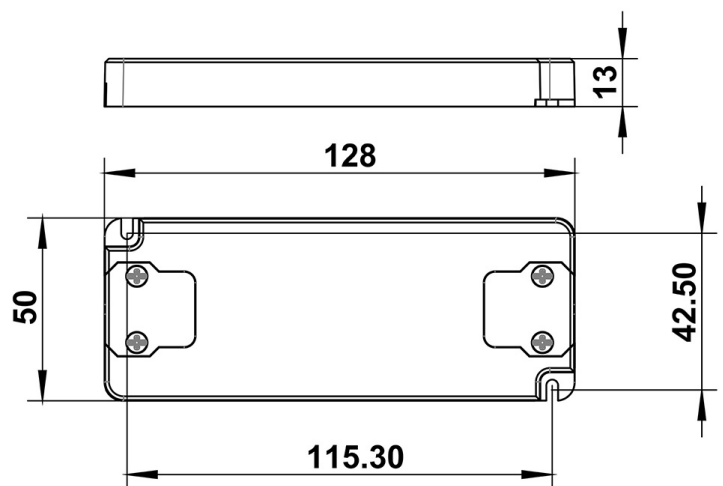

IP RATING



APPROVAL



Product Ordering

IMAGE	VOLTAGE	PART NUMBER
	12v DC	HV9666-12V20W
	24v DC	HV9666-24V20W

SAMPLE INSTALLATION DIAGRAM

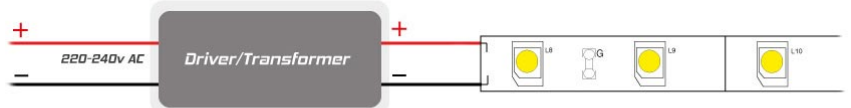

* Recommended maximum Load of 16w

** See Warranty Terms and Conditions for more information

For more information contact Havit Lighting

ADDRESS:
143 Beauchamp Road
Matraville NSW 2036
Australia

Tel: 02 9381 8300
Fax: 02 9666 8881
Email: sales@havit.com.au
web: www.havit.com.au

20w IP20 Indoor LED Strip Driver



Output	DC Voltage	12V	24V
	Voltage Tolerance	±0.5V	
	Voltage Regulation	± 0.5%	
	Rated current	1.67A	0.83A
	Rated power	20W	20W
Input	Voltage Range	220-240V AC	
	Frequency range	47 - 63HZ	
	Power Factor (Typ.)	PF≥0.97 (Full loading)	
	Full Load Efficiency(Typ.)	80%	82%
	AC Current(Max.)	0.32A	
	Leakage Current	<0.50mA	
Protection	Short Circuit	Hiccup mode, recovers automatically after fault condition is removed	
	Over Load	≤120% shut down o/p voltage, re-power on to recover after fault condition is removed	
	Over Temperature	100°C ± 10°C shut down o/p voltage, re-power on to recover	
	Protection Class:	II	
Environment	Working temperature	40 - +60°C	
	Working humidity	20 - 90%RH,non-condensing	
	Storage temp. and humidity	-40- + 80°C, 10-95%RH	
	Temp. coefficient	±0.03%/°C (0-50°C)	
	Vibration	10-500Hz,2G 12min./1 cycle,period for 72min.each along X.Y.Z axes.	
Safety and EMC	Safety standards	EN61347-1 EN61347-2-13 IP20	
	Withstand voltage	I/P-O/P:3.75KVAC I/P-FG:1.88KVAC O/P-FG:0.5KVAC	
	Insolation resistance	I/P-O/P I/P-FG O/P-FG:100MΩ/500VDC/25°C/70%RH	
	EMC Emission	EN55015,EN61000-3-2,3 (>60%loading)	
	EMC Immunity	EN61000-4-2,3,4,5,6,11,EN61547, A light industry level (Surge 4KV)	

For more information contact *Havit Lighting*

ADDRESS:
143 Beauchamp Road
Matraville NSW 2036
Australia

Tel: 02 9381 8300
Fax: 02 9666 8881
Email: sales@hav.it.com.au
web: www.hav.it.com.au