

PRODUCT SPECIFICATIONS

Product Code: HV9101-DX2

Material: Plastic

Colour: White

IP Rating: IP20

Dimmable: Yes

Output Signal: 2.4ghz

Transmitting Range: Up to 30m

Input Voltage: 240v AC

Warranty: 2 years replacement*



Must be used with HV9103-R4-5A

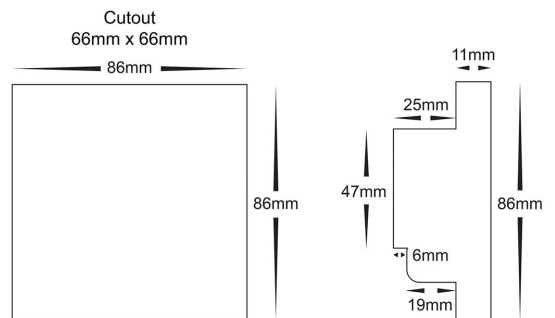
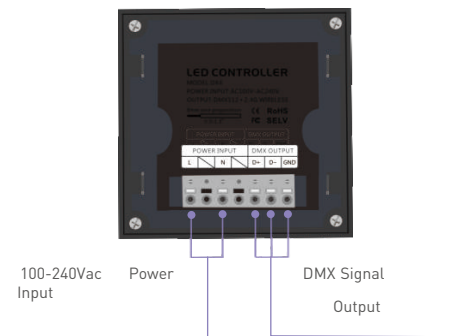
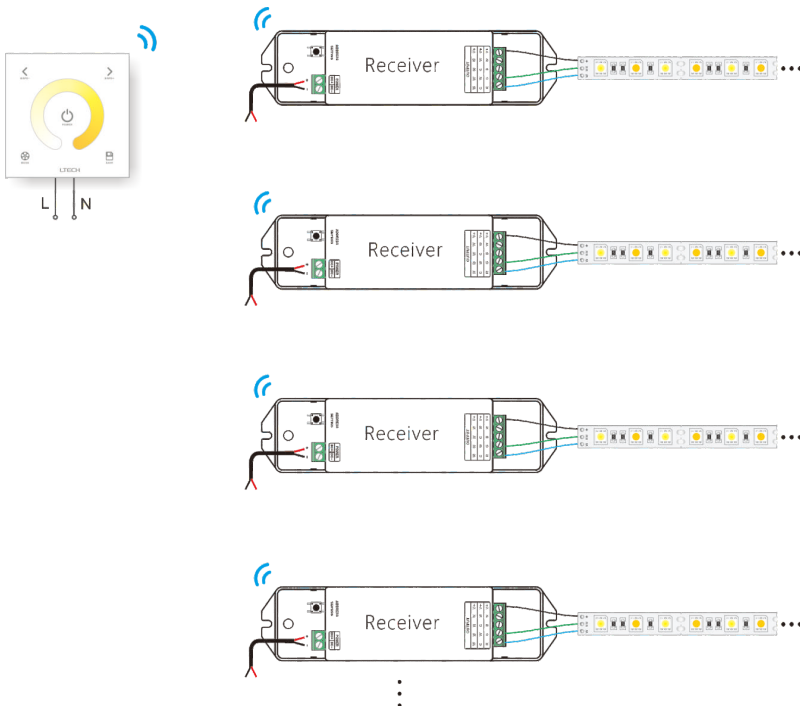

Sample wiring diagram

* See Warranty Terms and Conditions for more information