

EASY-250-RND

Variants	Item No.	Colour Temp
20954	EASY-250-RND-WHT	TRIO

Description: Polycarbonate ceiling light

Thank you for purchasing your new EASY-250-RND Ceiling Light, Please take the time to read and understand the instruction sheet below. Failure to do so may void warranty.

Specifications

Voltage:	240V AC	Lumen (±5%):	Warm White 3000K - 930lm Neutral White 4000K - 965lm White 5700K - 1000lm	Dimmable:	Yes
Power:	10W	Beam Angle:	120°	Operating Temp:	-20°C~45°C
IP Rating:	IP54	CCT:	3000K - 4000K - 5700K	Power Factor:	
CRI:	≥80	Lifespan:	50,000hrs		

1. Take out Easy and accessory pack from box



2. Press the side push tabs to take out the bracket

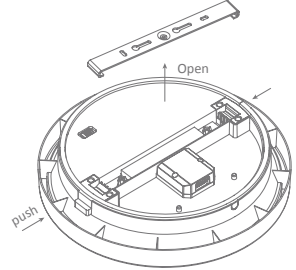

3. Knock-in the plastic anchor into ceiling. Fix bracket with screw into the ceiling.

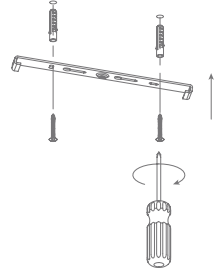

4. CCT switchable function: Choose CCT by slide switch before mounting to ceiling/wall.

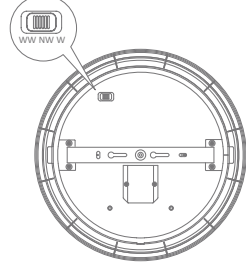

5. Remove the driver cover and line pressing clip, connect the wires correspondingly.

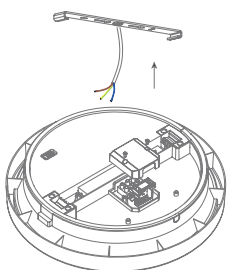

6. Insert the lamp on the bracket, make sure the lamp fixed well

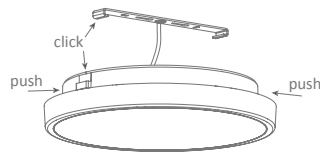

7. Switch on

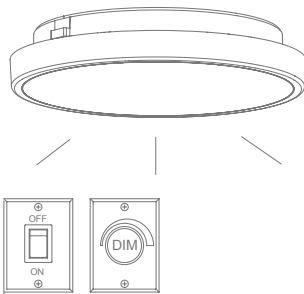

Note: -The lamp must be installed by professional electrician
-Ensure the power supply is switched off before fitting this product

-Do not touch the lamp when in use
-Keep away from hot steam and corrosive gas