

Driver 24V IP20 20W

Constant Voltage LED Driver



Description

DRIVER-24V-IP20 Series are a range of indoor non-dimmable 24V DC Constant Voltage LED Indoor Drivers for use with LED strip lighting, inground uplighters, garden spike lighting and much more. Secondary side short circuit protection. Thermal overload protection, over temperature protection and over voltage protection. Complete with 1M flex and plug. Non-dimmable. Indoor use only. Choose from 12W, 20W, 30W, 40W, 60W, 80W and 100W wattages. Parallel wiring. Backed by a 5 Year replacement Warranty.



Specification Features

Input Voltage:	240V AC
Power (W):	20W
Output Voltage:	24V DC
Output Current:	0.83A
Dimmable:	No
IP rating (IP):	IP20
Efficiency:	up to 89%; PF>0.95
Weight (g):	100
Size (mm):	100x36x18

Diagrams / Additional

Item No.	Variant	Wattage
DRIVER-24V-IP20	20208	20W

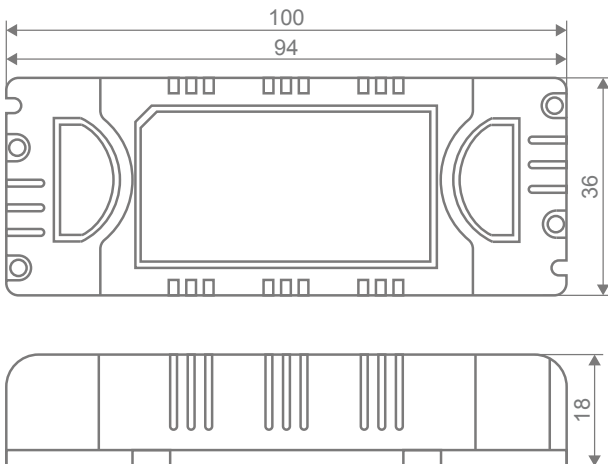

Driver 24V IP20 30W

Constant Voltage LED Driver



Description

DRIVER-24V-IP20 Series are a range of indoor non-dimmable 24V DC Constant Voltage LED Indoor Drivers for use with LED strip lighting, inground uplighters, garden spike lighting and much more. Secondary side short circuit protection. Thermal overload protection, over temperature protection and over voltage protection. Complete with 1M flex and plug. Non-dimmable. Indoor use only. Choose from 12W, 20W, 30W, 40W, 60W, 80W and 100W wattages. Parallel wiring. Backed by a 5 Year replacement Warranty.



Specification Features

Input Voltage:	240V AC
Power (W):	30W
Output Voltage:	24V DC
Output Current:	1.25A
Dimmable:	No
IP rating (IP):	IP20
Efficiency:	up to 89%; PF>0.95
Weight (g):	140
Size (mm):	107x40x22

Diagrams / Additional

Item No.	Variant	Wattage
DRIVER-24V-IP20	20209	30W

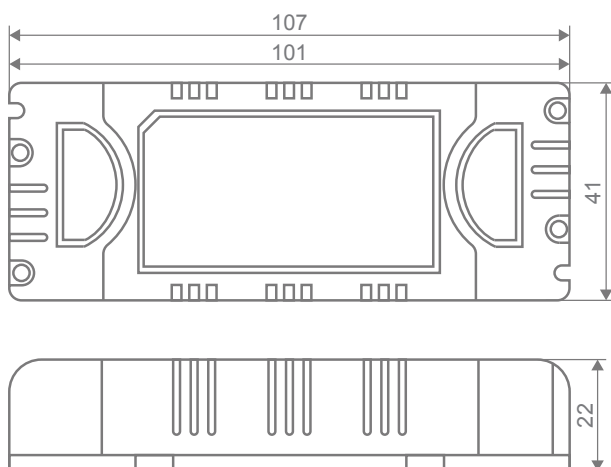

Driver 24V IP20 60W

Constant Voltage LED Driver



Description

DRIVER-24V-IP20 Series are a range of indoor non-dimmable 24V DC Constant Voltage LED Indoor Drivers for use with LED strip lighting, inground uplighters, garden spike lighting and much more. Secondary side short circuit protection. Thermal overload protection, over temperature protection and over voltage protection. Complete with 1M flex and plug. Non-dimmable. Indoor use only. Choose from 12W, 20W, 30W, 40W, 60W, 80W and 100W wattages. Parallel wiring. Backed by a 5 Year replacement Warranty.



Specification Features

Input Voltage:	240V AC
Power (W):	60W
Output Voltage:	24V DC
Output Current:	2.5A
Dimmable:	No
IP rating (IP):	IP20
Efficiency:	up to 89%; PF>0.95
Weight (g):	140
Size (mm):	133x47x29

Diagrams / Additional

Item No.	Variant	Wattage
DRIVER-24V-IP20	20211	60W

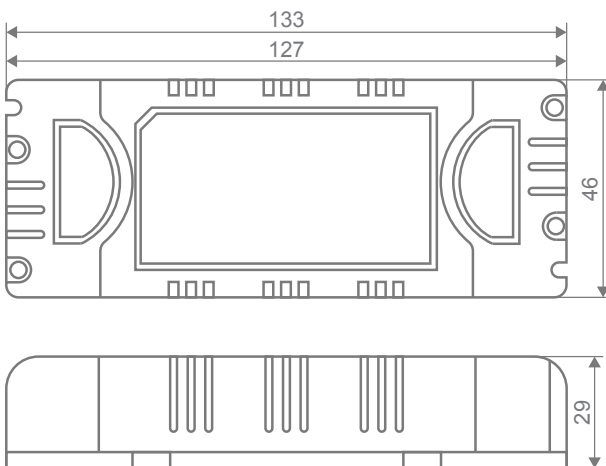

Driver 24V IP20 100W

Constant Voltage LED Driver



Description

DRIVER-24V-IP20 Series are a range of indoor non-dimmable 24V DC Constant Voltage LED Indoor Drivers for use with LED strip lighting, inground uplighters, garden spike lighting and much more. Secondary side short circuit protection. Thermal overload protection, over temperature protection and over voltage protection. Complete with 1M flex and plug. Non-dimmable. Indoor use only. Choose from 12W, 20W, 30W, 40W, 60W, 80W and 100W wattages. Parallel wiring. Backed by a 5 Year replacement Warranty.



Specification Features

Input Voltage:	240V AC
Power (W):	100W
Output Voltage:	24V DC
Output Current:	4.2A
Dimmable:	No
IP rating (IP):	IP20
Efficiency:	up to 89%; PF>0.95
Weight (g):	140
Size (mm):	189x65x30

Diagrams / Additional

Item No.	Variant	Wattage
DRIVER-24V-IP20	20213	100W

